



FM TRANSCEIVER

# FT-1802M

Technical Supplement

©2005 VERTEX STANDARD CO., LTD.

EH023N90A

**VERTEX STANDARD CO., LTD.**

4-8-8 Nakameguro, Meguro-Ku, Tokyo 153-8644, Japan

**VERTEX STANDARD**

**US Headquarters**

10900 Walker Street, Cypress, CA 90630, U.S.A.

**YAESU EUROPE B.V.**

P.O. Box 75525, 1118 ZN Schiphol, The Netherlands

**YAESU UK LTD.**

Unit 12, Sun Valley Business Park, Winnall Close  
Winchester, Hampshire, SO23 0LB, U.K.

**VERTEX STANDARD HK LTD.**

Unit 5, 20/F., Seaview Centre, 139-141 Hoi Bun Road,  
Kwun Tong, Kowloon, Hong Kong



## Introduction

This manual provides technical information necessary for servicing the FT-1802M FM Transceiver.

Servicing this equipment requires expertise in handling surface-mount chip components. Attempts by non-qualified persons to service this equipment may result in permanent damage not covered by the warranty, and may be illegal in some countries.

Two PCB layout diagrams are provided for each double-sided circuit board in the Transceiver. Each side of is referred to by the type of the majority of components installed on that side (“leaded” or “chip-only”). In most cases one side has only chip components, and the other has either a mixture of both chip and leaded components (trimmers, coils, electrolytic capacitors, ICs, etc.), or leaded components only.

While we believe the technical information in this manual to be correct, VERTEX STANDARD assumes no liability for damage that may occur as a result of typographical or other errors that may be present. Your cooperation in pointing out any inconsistencies in the technical information would be appreciated.

## Contents

<b>Specifications</b> .....	<b>2</b>	<b>Board Unit (Schematics, Layouts &amp; Parts)</b>	
<b>Exploded View &amp; Miscellaneous Parts</b> .....	<b>3</b>	MAIN Unit Circuit Diagram .....	13
<b>Block Diagram</b> .....	<b>5</b>	MAIN Unit Parts Layout .....	15
<b>Connection Diagram</b> .....	<b>6</b>	MAIN Unit Parts List .....	17
<b>Circuit Description</b> .....	<b>7</b>	CNTL Unit Circuit Diagram .....	27
<b>Alignment</b> .....	<b>9</b>	CNTL Parts Layout .....	28
		CNTL Parts List .....	29

# Specifications

## General

<b>Frequency Range:</b>	Tx 144 - 146 MHz or 144 - 148 MHz Rx 144 - 146 MHz or 136 - 174 MHz
<b>Channel Step:</b>	5/10/12.5/15/20/25/50/100 kHz
<b>Standard Repeater Shift:</b>	±600 kHz
<b>Frequency Stability:</b>	Better than ±10 ppm [-4 °F to +140 °F (-20 °C to +60 °C)]
<b>Modes of Emission:</b>	F2/F3
<b>Antenna Impedance:</b>	50 Ohms, unbalanced
<b>Supply voltage:</b>	13.8 V DC ±15%, negative ground
<b>Current Consumption (typical):</b>	Rx: less than 0.7 A, less than 0.3 A (squelched) Tx: 10 A (50 W) /7 A (25 W) /5 A (10 W) /4 A (5 W)
<b>Operating Temperature Range:</b>	-4° F to +140° F (-20° C to +60° C)
<b>Case Size (WxHxD):</b>	5.5" x 1.6" x 5.7" (140 x 40 x 146 mm) (w/o knobs)
<b>Weight (Approx.):</b>	2.6 lb (1.2 kg)

## Transmitter

<b>Output Power:</b>	50 W/25 W/10 W/5 W
<b>Modulation Type:</b>	Variable Reactance
<b>Maximum Deviation:</b>	±5 kHz/±2.5 kHz
<b>Spurious Radiation:</b>	Better than -60 dB
<b>Microphone Impedance:</b>	2000 Ohms

## Receiver

<b>Circuit Type:</b>	Double Conversion Superheterodyne
<b>IFs:</b>	21.7 MHz & 450 kHz
<b>Sensitivity (for 12dB SINAD):</b>	Better than 0.2 µV
<b>Selectivity (-6/-60dB):</b>	12 kHz/28 kHz
<b>IF Rejection:</b>	Better than 70 dB
<b>Image Rejection:</b>	Better than 70 dB
<b>Maximum AF Output:</b>	3 W into 4 Ohms @10 % THD

*Specifications subject to change without notice or obligation. Specifications guaranteed only within Amateur band. Frequency ranges and functions will vary according to transceiver version; check with your dealer.*

# Exploded View & Miscellaneous Parts

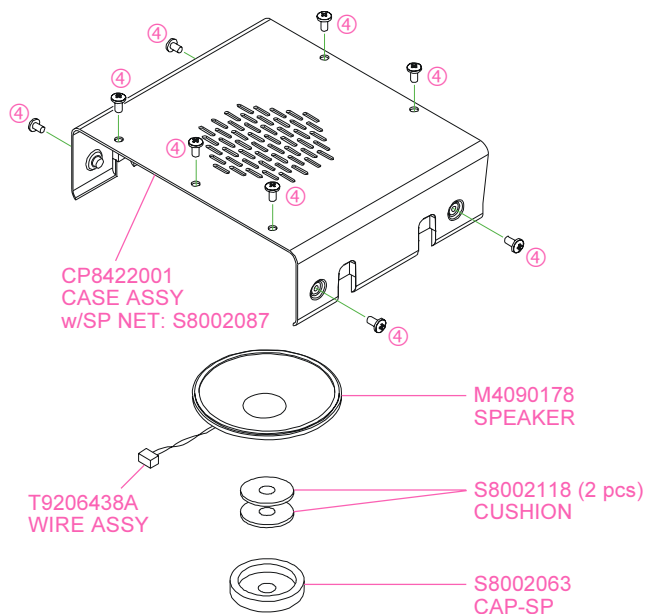

ACCESSORIES	
VXSTD P/N	DESCRIPTION
AAA43X001	MICROPHONE (MH-48A6J)
T9021715	DC CABLE (FT-1802M)
T9022815	DC CABLE (FT-1802E)
Q0000081	SPARE FUSE (15 A: FT-1802M)
Q0000075	SPARE FUSE (15 A: FT-1802E)
D6000055	BRACKET (MMB-36)
CB0297000	SCREW SET

REF.	VXSTD P/N	DESCRIPTION	QTY.
①	U03310002	SEMS SCREW ASM3X10NI	4
②	U24112002	TAPTITE SCREW M2X12NI	4
③	U24308002	TAPTITE SCREW M3X8NI	11
④	U36206007	TAPTITE SCREW M2.6X6B	9
⑤	U51320007	HEXA SOCKET BOLT M3X20B	3

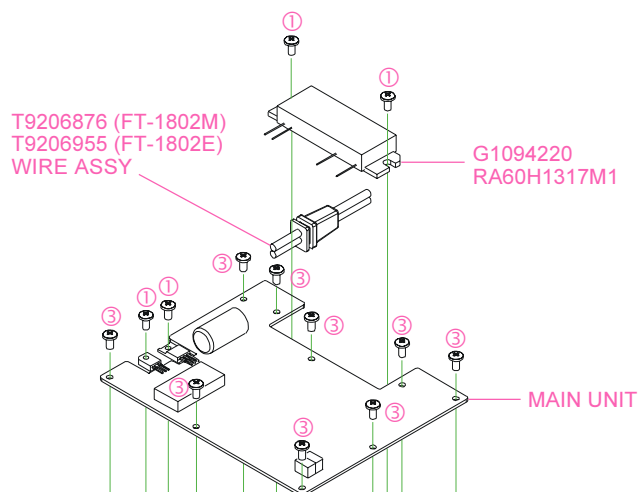

*Non-designated parts are available only as part of a designated assembly.*

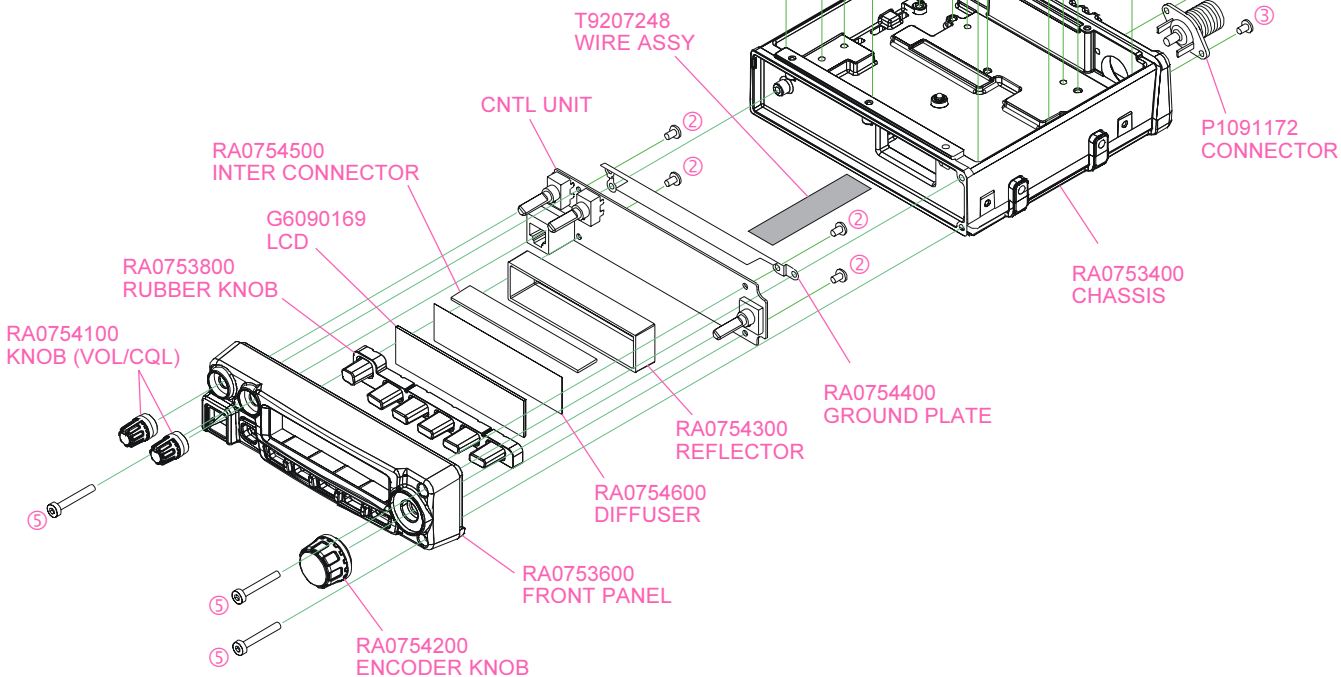

*Note*



# Connection Diagram

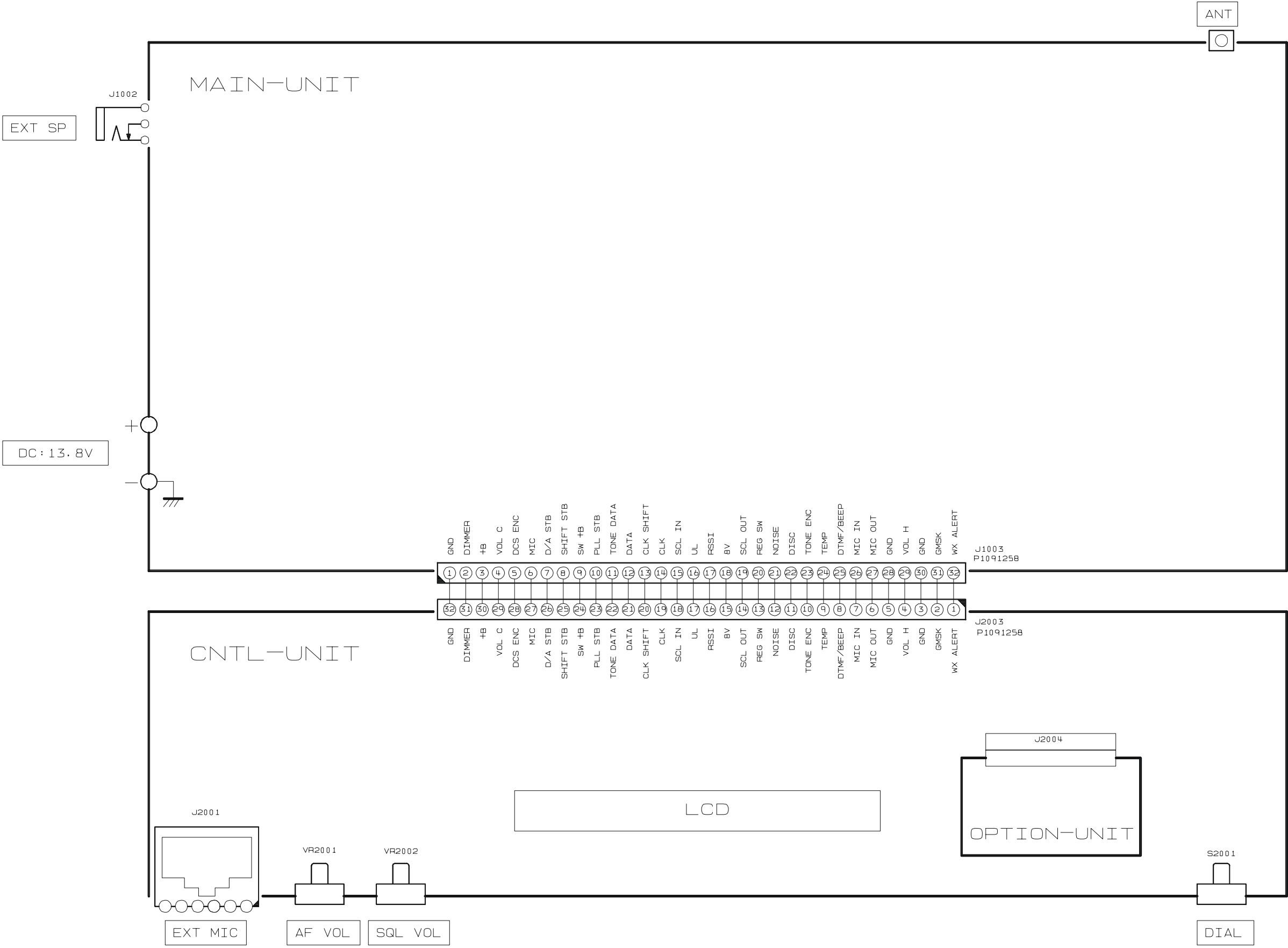

## Receive Signal Path

Incoming RF signal from the antenna jack is delivered to the Main Unit and passed through the low-pass filter network consisting of capacitors C1213, C1236, C1239, & C1241 and coils L1017, L1018, & L1019, antenna switching diode **D1020** and **D1028** (both **RLS135**), and varactor-tuned band-pass filter consisting of capacitors C1248, C1249, C1250, C1251, C1252, & C1268, coils L1020, L1021, & L1024, and diodes **D1024** and **D1025** (both **HVC350B**), before delivery to the RF amplifier **Q1045** (**3SK296ZQ**). The amplified RF signal is passed through another varactor-tuned band-pass filter consisting of capacitors C1198, C1199, C1200, & C1218, coils L1012 and L1015, and diodes **D1017** and **D1021** (both **HVC350B**), then applied to the 1st mixer **Q1037** (**3SK296ZQ**) along with the first local signal from the PLL circuit.

The first local signal is generated between 114.3 MHz and 152.3 MHz by the VCO, which consists of **Q1009** (**2SC5231**) and varactor diode **D1002** (**HVC350B**) according to the receiving frequency.

## IF and Audio Circuits

The 21.7 MHz first IF signal is applied to the monolithic crystal filters **XF1001** and **XF1002** which strip away unwanted mixer products, and the IF signal is applied to the first IF amplifier **Q1032** (**2SC4400**). The amplified first IF signal is then delivered to the FM IF subsystem IC **Q1028** (**NJM2591V**), which contains the second mixer, limiter amplifier, noise amplifier, and FM detector.

The second local signal is generated by 21.25 MHz crystal **X1001**, produces the 450 kHz second IF signal when mixed with first IF signal within **Q1028** (**NJM2591V**).

The 450 kHz second IF signal is applied to the ceramic filter **CF1001** (for Narrow FM) or **CF1002** (for Wide FM) which strip away unwanted mixer products to the ceramic discriminator **CD1001** which removes any amplitude variations in the 450 kHz IF signal before detection of speech.

The detected audio from the **Q1028** (**NJM2591V**) passes through the de-emphasis circuit consisting of resistors R1082 & R1113, and capacitors C1120 & C1122, to the audio mute gate **Q1034** (**2SJ364**)

The audio signal passes through a band-pass filter consisting of **Q1046** and **Q1047** (both **2SC4154**), and the audio mute gate **Q1039** (**2SJ347**), to the audio VR which adjusts the audio sensitivity to compensate for audio level variations. The adjusted audio signal is delivered to the audio amplifier **Q1035** (**LA4425A**) which provides up to 3 Watts, to the external speaker jack or a 4-Ohm loudspeaker.

## Squelch Control

When no carrier received, the noise signal from **Q1028** (**NJM2591V**) is amplified by **Q1051** (**2SC4617**), and is detected by **D1011** and **D1013** (both **DA221**). The resulting DC voltage passes through the SQL knob to main CPU **Q2002** (**HD64F2266TF13**). While no carrier is received, main CPU **Q2002** (**HD64F2266TF13**) control **Q1048** (**CD4094BPWR**), thus, audio mute gate **Q1034** (**2SJ364**) and **Q1039** (**2SJ347**) turns "OFF" to disable the audio output from the speaker.

## Transmit Signal Path

The speech signal from the microphone is amplified by **Q1049** (**LA2902PWR**). The amplified speech signal is subjected to the low-pass filter network **Q1049** (**LA2902PWR**) to deviation controlled by **Q1043** (**M62364FP**).

The adjusted speech signal from **Q1043** (**M62364FP**) is delivered to VCO **Q1009** (**2SC5231**) which frequency modulates the transmitting VCO made up of **D1004** (**HSC277**).

The modulated transmit signal passes through buffer amplifier **Q1010** and **Q1023** (both **2SC5374**).

The transmit signal applied to the drive amplifier **Q1026** (**2SC5226**), then finally amplified by power amplifier module **Q1030** (**RA60H1317M**) up to 50 Watts. The APC circuit controls the **Q1030** (**RA60H1317M**) power amplifier's gain.

The 50 Watts RF signal passes through low-pass filter network consisting of Capacitors C1210 and C1211 and coil L1013, antenna switch **D1018** and **D1019** (both **XB15A709**), and another low-pass filter network consisting of capacitors C1213, C1236, C1239, & C1241 and coils L1017, L1018, & L1019, and then deliver to the ANT jack.

## *Circuit Description*

### *TX APC Circuit*

A portion of the power amplifier module output is rectified by **D1022 (1SS321)**, then delivered to APC **Q1038 (LM2904PWR)**, as a DC voltage which is proportional to the output level of the power amplifier module.

The APC **Q1038 (LM2904PWR)** is compared the rectified DC voltage from the power amplifier module and the reference voltage from the main CPU **Q2002 (HD64F2266TF13)**, to produce a control voltage, which regulates supply voltage to the power amplifier module **Q1030 (RA60H1317M)**, so as to maintain stable output power under varying antenna loading condition.

### *PLL*

A portion of the output from the VCO **Q1009 (2SC5231)** passes through the buffer amplifier **Q1010** and **Q1017** (both **2SC5374**), then delivered to the programmable divider section of the PLL IC **Q1011 (MB15A01PFV1)**, which divided according

to the frequency dividing data that is associated with the setting frequency input from the main CPU **Q2002 (HD64F2266TF13)**. It is then sent to the phase comparator section of the PLL IC **Q1011 (MB15A01PFV1)**.

The 21.25 MHz frequency of the reference oscillator circuit made up of **X1001** is divided by the reference frequency divider section of **Q1011 (MB15A01PFV1)** into 4250 or 3400 parts to become 5 kHz or 6.25 kHz comparative reference frequencies, which are utilized by the phase comparator section of **Q1011 (MB15A01PFV1)**.

The phase comparator section of **Q1011 (MB15A01PFV1)** compares the phase between the frequency-divided oscillation frequency of the VCO circuit and comparative frequency and its output is a pulse corresponding to the phase difference. This pulse is integrated by the charge pump and loop filter into a control voltage (VCV) to control the oscillation frequency of the VCO **Q1009 (2SC5231)**.



## Introduction

The FT-1802M is carefully aligned at the factory for the specified performance across the amateur band. Realignment should therefore not be necessary except in the event of a component failure. Only an authorized Vertex Standard representative should perform all component replacement and service, or the warranty policy may be void.

The following procedures cover the adjustments that are not normally required once the transceiver has left the factory. However, if damage occurs and some parts subsequently are replaced, realignment may be required. If a sudden problem occurs during normal operation, it is likely due to component failure; realignment should not be done until after the faulty component has been replaced.

We recommend that servicing be performed only by authorized Vertex Standard service technicians who are experienced with the circuitry and fully equipped for repair and alignment. If a fault is suspected, contact the dealer from whom the transceiver was purchased for instructions regarding repair. Authorized Vertex Standard service technicians realign all circuits and make complete performance checks to ensure compliance with factory specifications after replacing any faulty components.

Those who do undertake any of the following alignments are cautioned to proceed at their own risk. Problems caused by unauthorized attempts at realignment are not covered by the warranty policy. Also, Vertex Standard reserves the right to change circuits and alignment procedures in the interest of improved performance, without notifying owners.

Under no circumstances should any alignment be attempted unless the normal function and operation of the transceiver are clearly understood, the cause of the malfunction has been clearly pinpointed and any faulty components replaced, and realignment determined to be absolutely necessary.

## Required Test Equipment

The following test equipment (and familiarity with its use) is necessary for complete realignment. Correction of problems caused by misalignment resulting from use of improper test equipment is not covered under the warranty policy. While most steps do not require all of the equipment listed, the interactions of some adjustments may require that more complex adjustments be performed afterwards.

Do not attempt to perform only a single step unless it is clearly isolated electrically from all other steps. Have all test equipment ready before beginning and, follow all of the steps in a section in the order presented.

- RF Signal Generator with calibrated output level at 200 MHz
- Deviation Meter (linear detector)
- In-line Wattmeter with 5% accuracy at 200 MHz
- 50-Ohm 50-W RF Dummy Load
- 8-Ohm AF Dummy Load
- Regulated DC Power Supply adjustable from 6 to 15 VDC, 10A
- Frequency Counter: 0.2-ppm accuracy at 200 MHz
- AF Signal Generator
- AC Voltmeter
- DC Voltmeter: high impedance
- VHF Sampling Coupler
- SINAD Meter

# Alignment

## Alignment Preparation & Precautions

A 50-Ohm RF load and in-line wattmeter must be connected to the antenna jack in all procedures that call for transmission; alignment is not possible with an antenna. After completing one step, read the next step to see if the same test equipment is required. If not, remove the test equipment (except dummy load and wattmeter, if connected) before proceeding.

Correct alignment requires that the ambient temperature be the same as that of the transceiver and test equipment, and that this temperature be held constant between 68 °F ~ 86 °F (20 °C ~ 30 °C). When the transceiver is brought into the shop from hot or cold air, it should be allowed some time to come to room temperature before alignment. Whenever possible, alignments should be made with oscillator shields and circuit boards firmly affixed in place. Also, the test equipment must be thoroughly warmed up before beginning.

*Note:* Signal levels in dB referred to in the alignment procedure are based on  $0\text{dB}\mu = 0.5\mu\text{V}$ .

## Test Setup

Set up the test equipment as shown below for transceiver alignment.

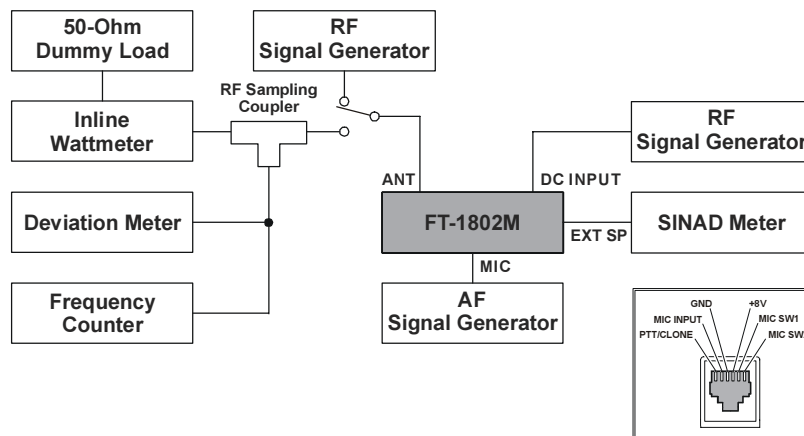

**TEST EQUIPMENT SETUP**

## Entering the Alignment Mode

Alignment of the FT-1802M is performed using a front panel software-based procedure. To perform alignment of the transceiver, it must first be placed in the “Alignment Mode,” in which the adjustments will be made and then stored into memory.

To enter the Alignment mode, press and hold in the [REV(DW)] and [D/MR(MW)] keys while turning the radio on. Once the radio is on, release these two key. The transceiver is now in the “Alignment Mode.”

### PLL Reference Frequency

- Rotate the **DIAL** knob to set the alignment parameter to “148.000 rF.”
- Press the [D/MR(MW)] key to enable adjustment of the “PLL Reference Frequency.”
- Press the **PTT** switch to activate the transmitter, adjust the **DIAL** knob so that the counter frequency reading is 148.000 MHz ( $\pm 100$  Hz).
- Press the [D/MR(MW)] key.

### RF Front-end Tuning

- Inject a 145.100 MHz signal at a level of  $-10\text{ dB}\mu$  (with 1 kHz modulation @  $\pm 3.5$  kHz deviation) from the RF signal generator.
- Rotate the **DIAL** knob to set the alignment parameter to “145.100 tn.”
- Press the [D/MR(MW)] key to enable adjustment of the “RF Front-end Tuning.”
- Adjust the **DIAL** knob so that the maximum SINAD.
- Press the [D/MR(MW)] key.

## Squelch Threshold Level

- ❑ Inject a 145.100 MHz signal at a level of  $-14$  dB $\mu$  (with 1 kHz modulation @ $\pm 3.5$  kHz deviation) from the RF signal generator.
- ❑ Rotate the **SQL** knob to the 10-o'clock position.
- ❑ Rotate the **DIAL** knob to set the alignment parameter to "145.100 tL."
- ❑ Press the **[D/MR(MW)]** key to enable adjustment of the "Squelch Threshold Level."
- ❑ Press the **[D/MR(MW)]** key three times.
- ❑ Press the **[D/MR(MW)]** key.

## S-meter Level (S-1)

- ❑ Inject a 145.100 MHz signal at a level of  $-5$  dB $\mu$  (with 1 kHz modulation @ $\pm 3.5$  kHz deviation) from the RF signal generator.
- ❑ Rotate the **DIAL** knob to set the alignment parameter to "145.100 S1."
- ❑ Press the **[D/MR(MW)]** key to enable adjustment of the "S-meter Level (S-1)."
- ❑ Press the **[D/MR(MW)]** key three times.
- ❑ Press the **[D/MR(MW)]** key.

## S-meter Level (S-9)

- ❑ Inject a 145.100 MHz signal at a level of  $+20$  dB $\mu$  (with 1 kHz modulation @ $\pm 3.5$  kHz deviation) from the RF signal generator.
- ❑ Rotate the **DIAL** knob to set the alignment parameter to "145.100 S9."
- ❑ Press the **[D/MR(MW)]** key to enable adjustment of the "S-meter Level (S-9)."
- ❑ Press the **[D/MR(MW)]** key three times.
- ❑ Press the **[D/MR(MW)]** key.

## TX Power (High)

- ❑ Rotate the **DIAL** knob to set the alignment parameter to "145.000 HP."
- ❑ Press the **[D/MR(MW)]** key to enable adjustment of the "TX Power (High)."
- ❑ Press the **PTT** switch to activate the transmitter, adjust the **DIAL** knob so that the RF Power Meter reading is 50 W ( $\pm 2.0$ W).
- ❑ Press the **[D/MR(MW)]** key.

## TX Power (Low 3)

- ❑ Rotate the **DIAL** knob to set the alignment parameter to "145.000 L3."
- ❑ Press the **[D/MR(MW)]** key to enable adjustment of the "TX Power (Low 3)."
- ❑ Press the **PTT** switch to activate the transmitter, adjust the **DIAL** knob so that the RF Power Meter reading is 25 W ( $\pm 1.5$  W).
- ❑ Press the **[D/MR(MW)]** key.

## TX Power (Low 2)

- ❑ Rotate the **DIAL** knob to set the alignment parameter to "145.000 L2."
- ❑ Press the **[D/MR(MW)]** key to enable adjustment of the "TX Power (Low 2)."
- ❑ Press the **PTT** switch to activate the transmitter, adjust the **DIAL** knob so that the RF Power Meter reading is 10 W ( $\pm 1.0$  W).
- ❑ Press the **[D/MR(MW)]** key.

## TX Power (Low 1)

- ❑ Rotate the **DIAL** knob to set the alignment parameter to "145.000 L1."
- ❑ Press the **[D/MR(MW)]** key to enable adjustment of the "TX Power (Low 1)."
- ❑ Press the **PTT** switch to activate the transmitter, adjust the **DIAL** knob so that the RF Power Meter reading is 5 W ( $\pm 0.5$  W).
- ❑ Press the **[D/MR(MW)]** key.

## TX Deviation

- ❑ Inject a 1 kHz, 50 mV signal from the Audio Generator.
- ❑ Rotate the **DIAL** knob to set the alignment parameter to "145.000 dU."
- ❑ Press the **[D/MR(MW)]** key to enable adjustment of the "TX Deviation."
- ❑ Press the **PTT** switch to activate the transmitter, adjust the **DIAL** knob so that the Deviation Meter reading is 4.2 kHz ( $\pm 0.1$  kHz) (EXP version: 4.5 kHz  $\pm 0.1$  kHz).
- ❑ Press the **[D/MR(MW)]** key.

# *Alignment*

## **CTCSS TX Deviation**

- Rotate the **DIAL** knob to set the alignment parameter to “145.000 100.”
- Press the [**D/MR(MW)**] key to enable adjustment of the “CTCSS TX Deviation.”
- Press the **PTT** switch to activate the transmitter, adjust the **DIAL** knob so that the Deviation Meter reading is 0.6 kHz ( $\pm 0.05$  kHz).
- Press the [**D/MR(MW)**] key.

## **DCS TX Deviation**

- Rotate the **DIAL** knob to set the alignment parameter to “145.000 dC.”
- Press the [**D/MR(MW)**] key to enable adjustment of the “DCS TX Deviation.”
- Press the **PTT** switch to activate the transmitter, adjust the **DIAL** knob so that the Deviation Meter reading is 0.6 kHz ( $\pm 0.05$  kHz).
- Press the [**D/MR(MW)**] key.

## *Closing the Alignment mode*

Press the [**DW(REV)**] key to save the new setting and exit to normal operation.

# MAIN Unit Circuit Diagram

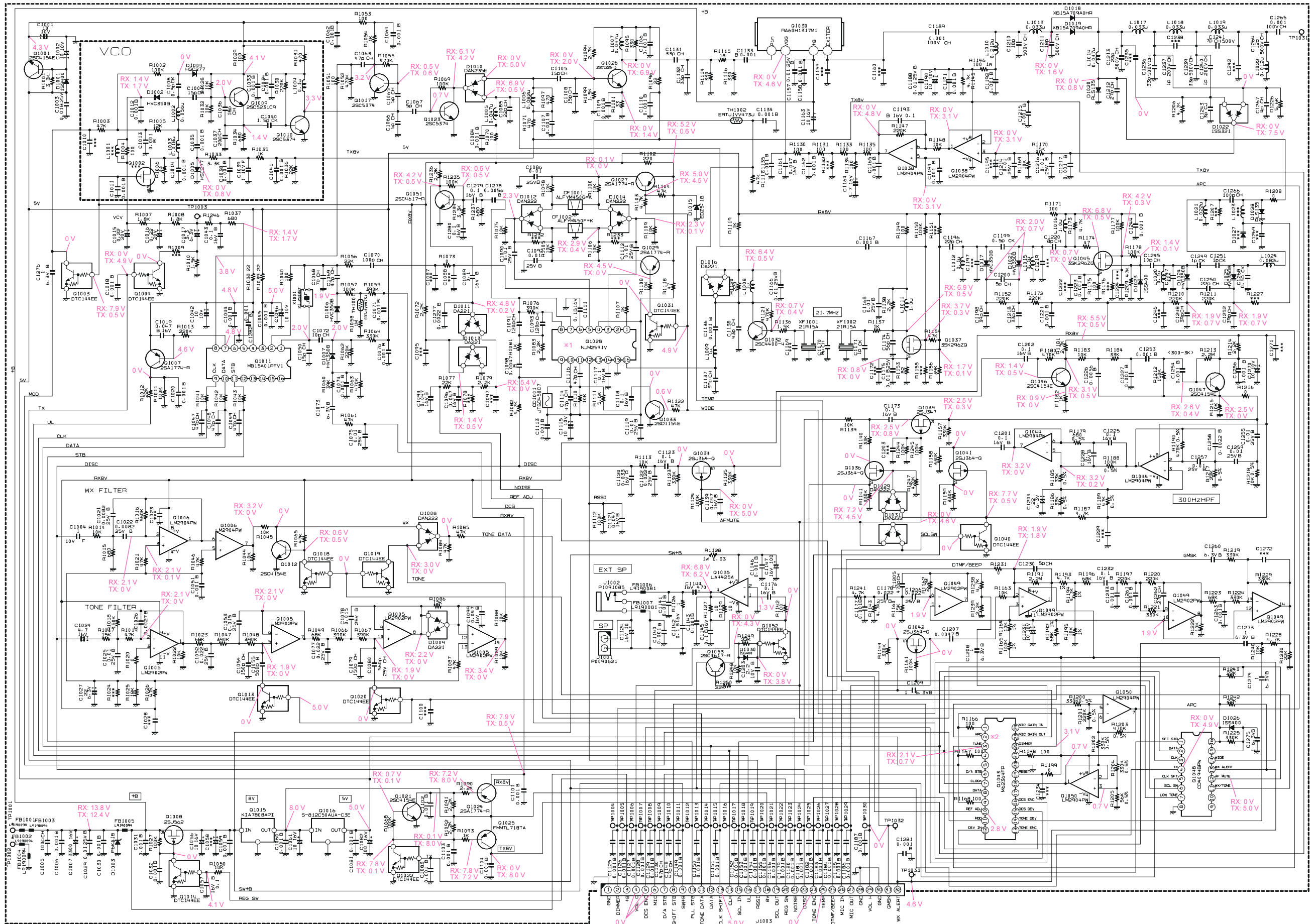

\*1 Q1028

Pin	RX	TX
1	5.0V	5.0V
2	0V	0V
3	3.0V	0V
4	5.0V	0.5V
5	5.0V	0.5V
6	5.0V	0.5V
7	0V	0V
8	0.7V	0V
9	1.1V	0V
10	5.0V	0.5V
11	4.2V	0.1V
12	0.6V	0V
13	0V	0V
14	0V	0V
15	0V	0V
16	1.6V	0V

\*2 Q1043 Pin 2

RX: 0.7V
TX (LOW 1): 2.1V
TX (LOW 2): 2.5V
TX (LOW 3): 3.3V
TX (HIGH): 4.3V

# *MAIN Unit*

*Note*



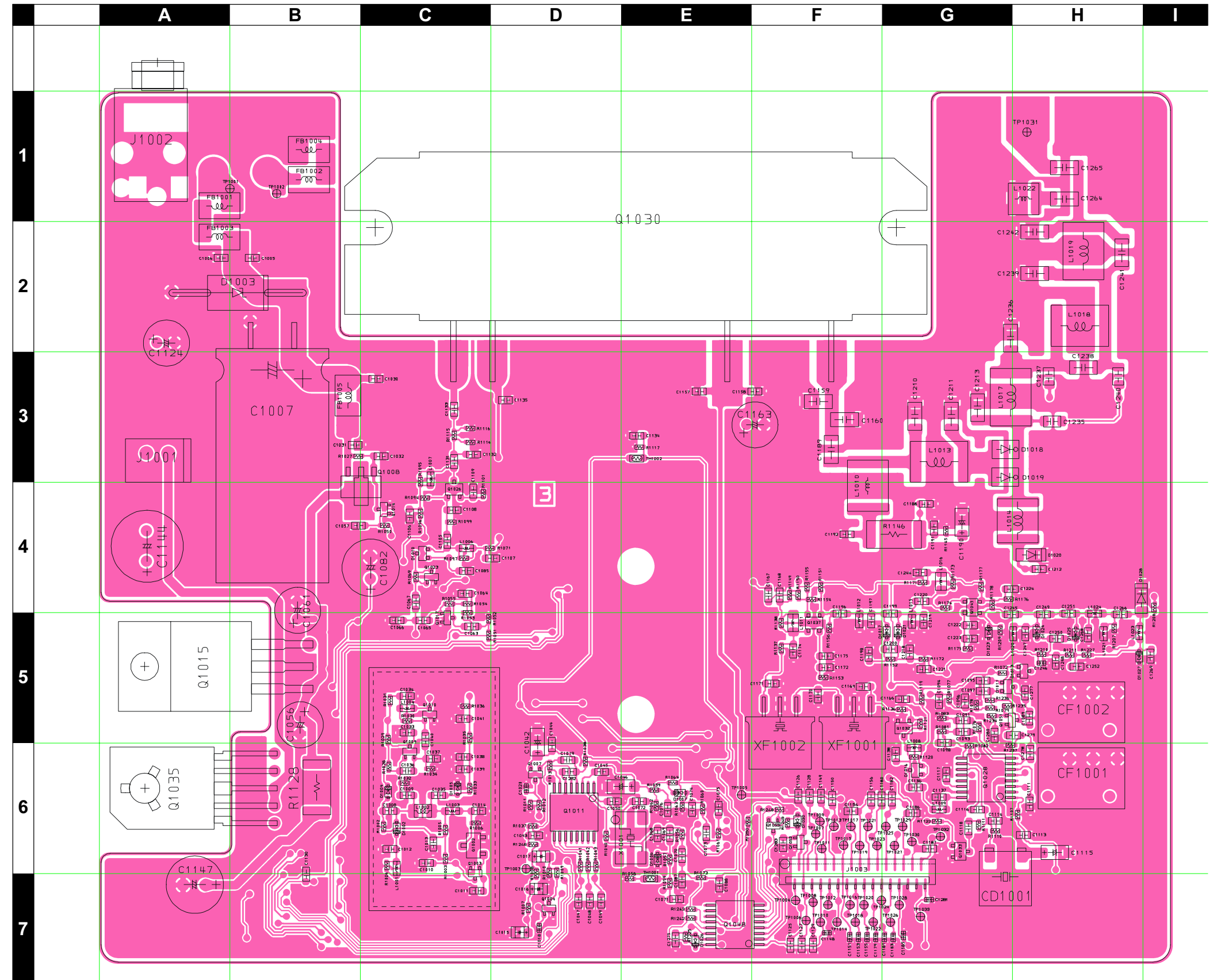
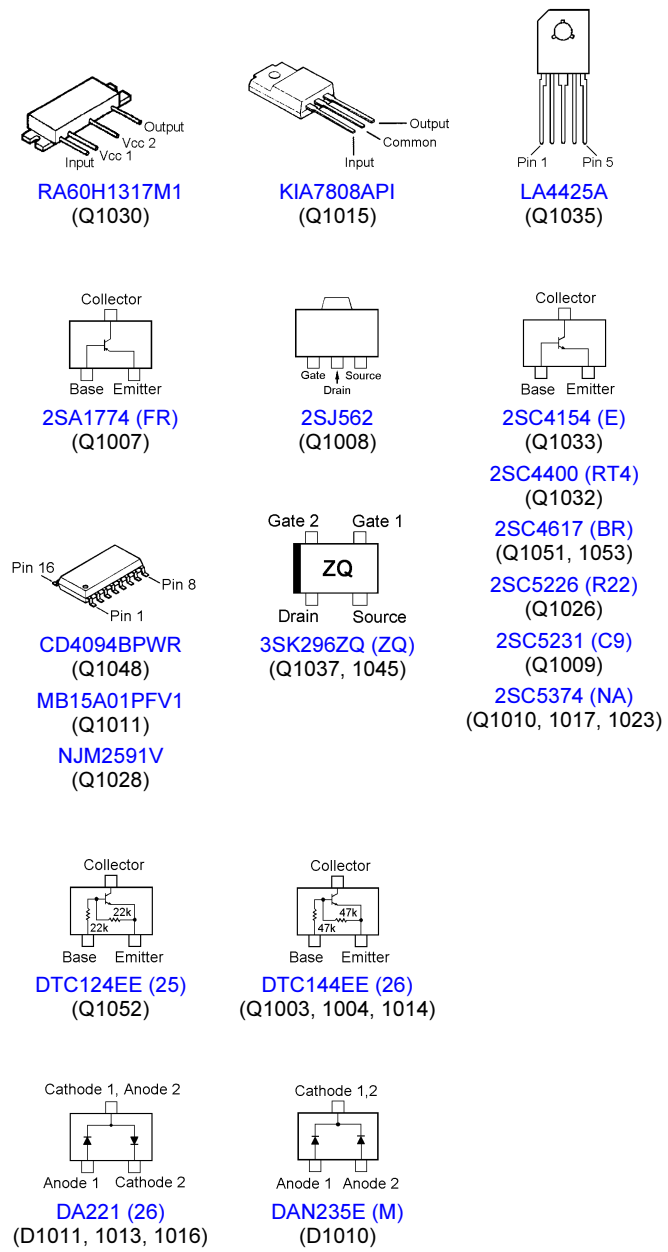

# MAIN Unit

## Parts Layout (Side B)

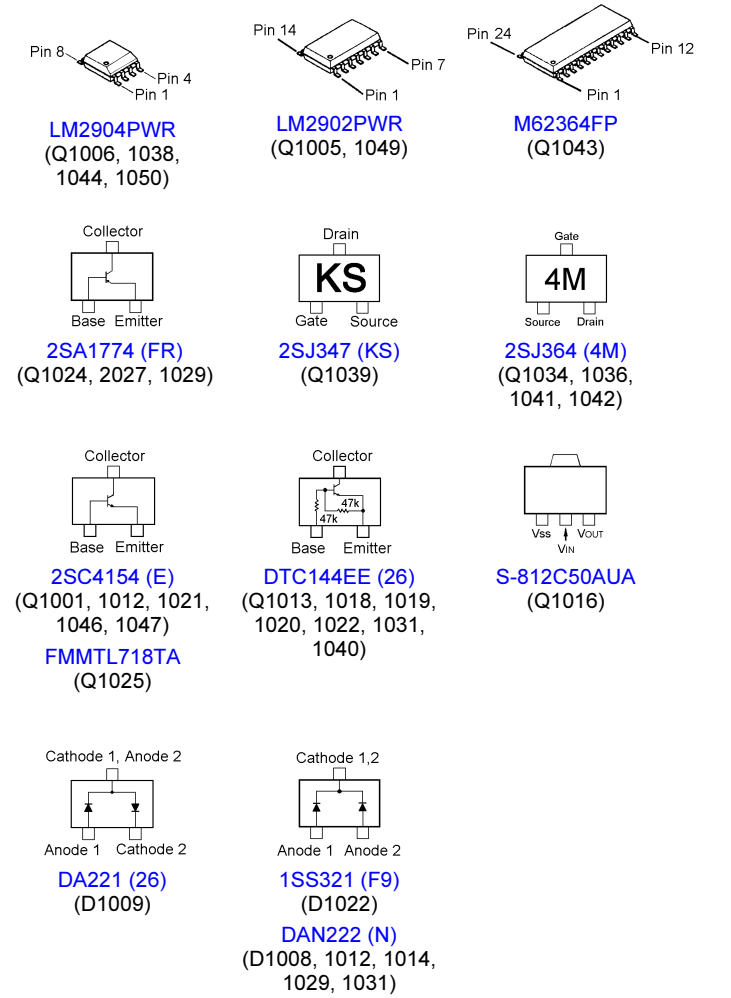
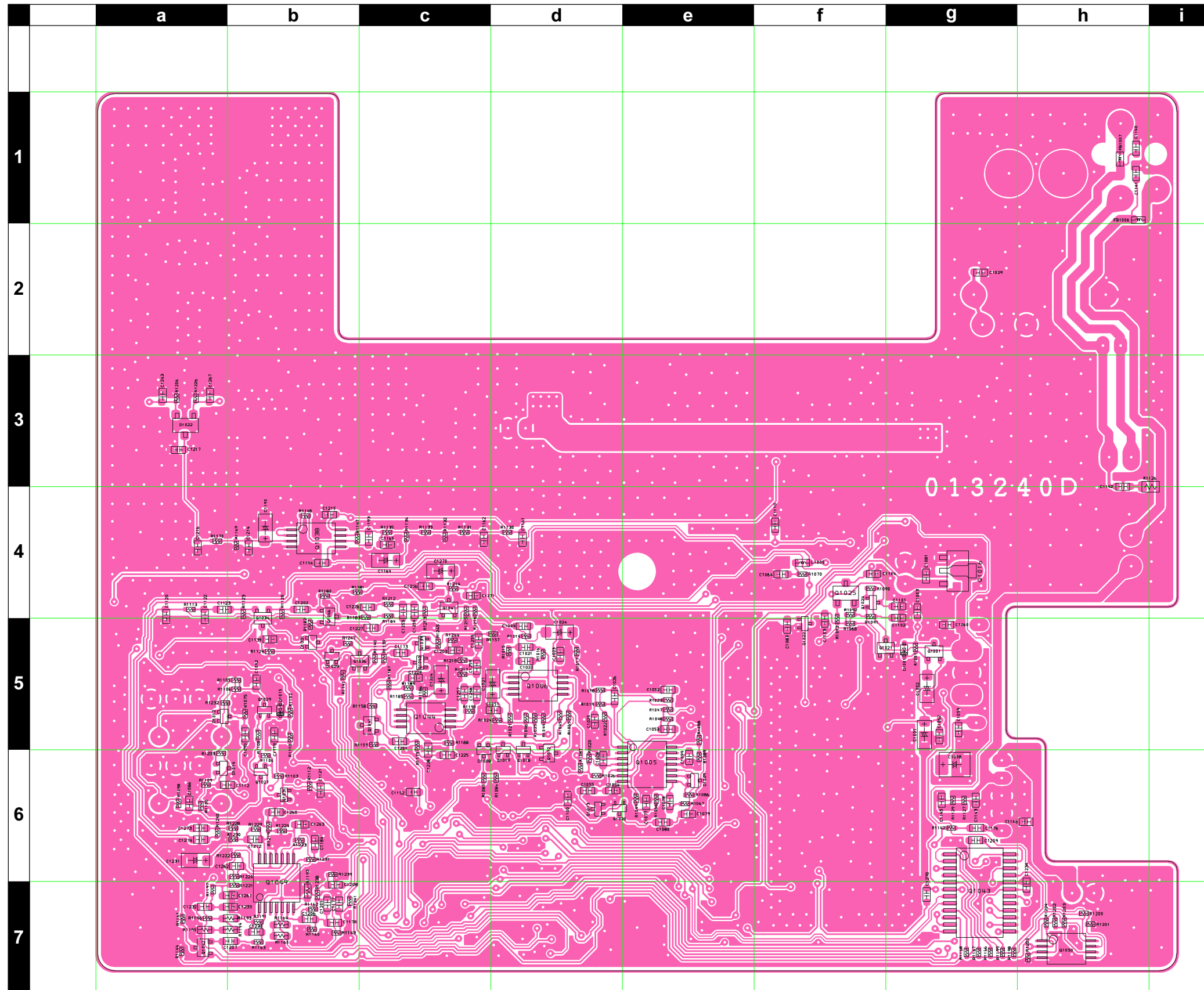



REF	DESCRIPTION	VALUE	V/W	TOL.	MFR'S DESIG	VXSTD P/N	VERS.	LOT	SIDE	LAY ADR
PCB with Components						CB3119001	FT-1802M			
						CB3119002	FT-1802E			
Printed Circuit Board					AH023N000	FR0132400				1-
C 1001	CHIP TA.CAP.	10uF	10V		TAJA106M010Y	K78100072		1-	B	g5
C 1002	CHIP TA.CAP.	10uF	10V		TAJA106M010Y	K78100072		1-	B	g5
C 1003	CHIP CAP.	0.01uF	25V		GRM39B103M25PT	K22144802		1-	B	g4
C 1004	CHIP CAP.	1uF	10V	F	GRM188F11A105ZA01D	K22105001		1-	B	d5
C 1005	CHIP CAP.	100pF	50V	CH	GRM1882C1H101JA01D	K22174235		1-	A	B2
C 1006	CHIP CAP.	0.001uF	50V	B	GRM188B11H102KA01D	K22174809		1-	A	A2
C 1007	AL.ELECTRO.CAP.	3300uF	16V		RE3-16V332M 3300UF	K40129065		1-	A	B2
C 1008	CHIP CAP.	0.5pF	50V	CK	GRM1884C1HR50CZ01D	K22174201		1-	A	C6
C 1009	CHIP CAP.	15pF	50V	CH	GRM1882C1H150JA01D	K22174215		1-	A	C6
C 1011	CHIP CAP.	0.001uF	50V	B	GRM188B11H102KA01D	K22174809		1-	A	C7
C 1012	CHIP CAP.	0.001uF	50V	B	GRM188B11H102KA01D	K22174809		1-	A	C6
C 1013	CHIP CAP.	0.001uF	50V	B	GRM188B11H102KA01D	K22174809		1-	A	C6
C 1014	CHIP CAP.	0.001uF	50V	B	GRM188B11H102KA01D	K22174809		1-	A	C6
C 1015	CHIP TA.CAP.	0.22uF	20V		TMCP1D224MTRF	K78130069		1-	A	D7
C 1016	CHIP TA.CAP.	0.22uF	20V		TMCP1D224MTRF	K78130069		1-	A	D7
C 1017	CHIP TA.CAP.	3.3uF	6.3V		TESVSP0J335M-8R	K78080052		1-	A	D6
C 1018	CHIP CAP.	0.001uF	50V	B	GRM155B11H102KA01D	K22178809		1-	A	D7
C 1019	CHIP CAP.	0.047uF	16V	B	GRM39B473K16PT	K22124804		1-	A	D6
C 1020	CHIP CAP.	0.001uF	50V	B	GRM155B11H102KA01D	K22178809		1-	A	D6
C 1021	CHIP CAP.	0.0082uF	25V	B	GRM39B822M25PT	K22144801		1-	B	d5
C 1022	CHIP CAP.	0.0082uF	25V	B	GRM39B822M25PT	K22144801		1-	B	d5
C 1024	CHIP TA.CAP.	4.7uF	16V		TAJA475M016Y	K78120079		1-	B	d5
C 1025	CHIP CAP.	0.01uF	25V	B	GRM39B103M25PT	K22144802		1-	B	d5
C 1026	CHIP CAP.	0.0027uF	50V	B	GRM188B11H272KA01D	K22174814		1-	B	d5
C 1027	CHIP TA.CAP.	22uF	6.3V		TAJA226M006Y	K78080086		1-	B	d5
C 1029	CHIP CAP.	0.01uF	25V	B	GRM39B103K25PT	K22144803		1-	B	g2
C 1030	CHIP CAP.	0.001uF	50V	B	GRM188B11H102KA01D	K22174809		1-	A	C3
C 1031	CHIP CAP.	0.001uF	50V	B	GRM188B11H102KA01D	K22174809		1-	A	B3
C 1032	CHIP CAP.	0.001uF	50V	B	GRM188B11H102KA01D	K22174809		1-	A	C3
C 1033	CHIP CAP.	0.001uF	50V	B	GRM188B11H102KA01D	K22174809		1-	A	C5
C 1034	CHIP CAP.	0.001uF	50V	B	GRM188B11H102KA01D	K22174809		1-	A	C5
C 1035	CHIP CAP.	0.001uF	50V	B	GRM188B11H102KA01D	K22174809		1-	A	C6
C 1036	CHIP CAP.	18pF	50V	CH	GRM1882C1H180JA01D	K22174217		1-	A	C6
C 1037	CHIP CAP.	20pF	50V	CH	GRM1882C1H200JZ01D	K22174218		1-	A	C6
C 1038	CHIP CAP.	0.001uF	50V	B	GRM188B11H102KA01D	K22174809		1-	A	C6
C 1039	CHIP CAP.	1uF	10V	F	GRM188F11A105ZA01D	K22105001		1-	A	C6
C 1040	CHIP CAP.	1.5pF	50V	CK	GRM1884C1H1R5CZ01D	K22174258		1-	A	C5
C 1041	CHIP CAP.	0.001uF	50V	B	GRM188B11H102KA01D	K22174809		1-	A	C5
C 1042	CHIP TA.CAP.	10uF	10V		TAJA106M010Y	K78100072		1-	A	D5
C 1043	CHIP CAP.	0.1uF	16V	B	GRM188B11C104KA01D	K22124805		1-	A	D6
C 1044	CHIP CAP.	0.001uF	50V	B	GRM188B11H102KA01D	K22174809		1-	A	D5
C 1045	CHIP CAP.	0.001uF	50V	B	GRM188B11H102KA01D	K22174809		1-	A	D6
C 1046	CHIP TA.CAP.	10uF	10V		TAJA106M010Y	K78100072		1-	A	D6
C 1047	CHIP CAP.	47pF	50V	CH	GRM1882C1H470JA01D	K22174227		1-	A	D7
C 1048	CHIP CAP.	47pF	50V	CH	GRM1882C1H470JA01D	K22174227		1-	A	D7
C 1049	CHIP CAP.	47pF	50V	CH	GRM1882C1H470JA01D	K22174227		1-	A	D7
C 1050	CHIP CAP.	15pF	50V	CH	GRM1882C1H150JA01D	K22174215		1-	A	D6
C 1051	CHIP CAP.	0.001uF	50V	B	GRM188B11H102KA01D	K22174809		1-	B	d5
C 1052	CHIP CAP.	0.022uF	25V	B	GRM39B223K25PT	K22144807		1-	B	e5
C 1053	CHIP CAP.	0.015uF	25V	B	GRM39B153K25PT	K22144805		1-	B	e5
C 1054	CHIP CAP.	150pF	50V	CH	GRM1882C1H151JA01D	K22174239		1-	B	d6
C 1055	CHIP CAP.	560pF	50V	B	GRM188B11H561KA01D	K22174806		1-	B	d6
C 1056	AL.ELECTRO.CAP.	10uF	16V		RE2-16V100MMA	K40129004		1-	A	B5
C 1057	CHIP CAP.	0.1uF	16V	B	GRM188B11C104KA01D	K22124805		1-	A	B4
C 1059	CHIP CAP.	0.001uF	50V	B	GRM188B11H102KA01D	K22174809		1-	B	g5
C 1060	CHIP CAP.	0.001uF	50V	B	GRM188B11H102KA01D	K22174809		1-	B	g5
C 1061	AL.ELECTRO.CAP.	10uF	16V		RE2-16V100MMA	K40129004		1-	A	B5
C 1062	CHIP CAP.	0.001uF	50V	B	GRM188B11H102KA01D	K22174809		1-	B	g5
C 1063	CHIP CAP.	47pF	50V	CH	GRM1882C1H470JA01D	K22174227		1-	A	C5
C 1064	CHIP CAP.	0.001uF	50V	B	GRM188B11H102KA01D	K22174809		1-	A	C4
C 1065	CHIP CAP.	5pF	50V	CH	GRM1882C1H5R0CZ01D	K22174206		1-	A	C5
C 1066	CHIP CAP.	5pF	50V	CH	GRM1882C1H5R0CZ01D	K22174206		1-	A	C5
C 1067	CHIP CAP.	5pF	50V	CH	GRM1882C1H5R0CZ01D	K22174206		1-	A	C4
C 1068	CHIP CAP.	7pF	50V	CH	GRM1882C1H7R0DZ01D	K22174208		1-	A	E6
C 1069	CHIP CAP.	47pF	50V	CH	GRM1882C1H470JA01D	K22174227		1-	A	E6
C 1070	CHIP CAP.	100pF	50V	CH	GRM1882C1H101JA01D	K22174235		1-	A	E6
C 1071	CHIP CAP.	0.001uF	50V	B	GRM188B11H102KA01D	K22174809		1-	A	E7
C 1072	CHIP CAP.	10pF	50V	CH	GRM1882C1H100JA01D	K22174211		1-	A	E6
C 1073	CHIP CAP.	1uF	6.3V	B	GRM188B10J105KA01D	K22084801		1-	A	E6
C 1074	CHIP CAP.	0.001uF	50V	B	GRM188B11H102KA01D	K22174809		1-	A	E6
C 1075	CHIP CAP.	0.01uF	25V	B	GRM39B103M25PT	K22144802		1-	A	E6
C 1076	CHIP CAP.	0.001uF	50V	B	GRM188B11H102KA01D	K22174809		1-	A	E6

# MAIN Unit

## Parts List

REF	DESCRIPTION	VALUE	V/W	TOL.	MFR'S DESIG	VXSTD P/N	VERS.	LOT	SIDE	LAY ADR
C 1077	CHIP CAP.	0.022uF	25V	B	GRM39B223K25PT	K22144807		1-	B	e6
C 1078	CHIP CAP.	0.015uF	25V	B	GRM39B153K25PT	K22144805		1-	B	e6
C 1079	CHIP CAP.	150pF	50V	CH	GRM1882C1H151JA01D	K22174239		1-	B	e6
C 1080	CHIP CAP.	560pF	25V	CH	GRM39CH561J25PT	K22144201		1-	B	e6
C 1081	CHIP CAP.	0.001uF	50V	B	GRM188B11H102KA01D	K22174809		1-	B	g4
C 1082	AL.ELECTRO.CAP.	100uF	16V		RC2-16V101MB	K40129038		1-	A	C4
C 1083	CHIP CAP.	0.001uF	50V	B	GRM188B11H102KA01D	K22174809		1-	B	f5
C 1084	CHIP CAP.	0.001uF	50V	B	GRM188B11H102KA01D	K22174809		1-	B	f4
C 1085	CHIP CAP.	22pF	50V	CH	GRM1882C1H220JA01D	K22174219		1-	A	C4
C 1086	CHIP CAP.	0.01uF	25V	B	GRM39B103M25PT	K22144802		1-	B	a6
C 1089	CHIP CAP.	0.1uF	16V	B	GRM188B11C104KA01D	K22124805		1-	A	H5
C 1090	CHIP CAP.	0.01uF	25V	B	GRM39B103M25PT	K22144802		1-	B	b5
C 1091	CHIP CAP.	120pF	50V	CH	GRM1882C1H121JA01D	K22174237		1-	A	G5
C 1092	CHIP CAP.	0.01uF	25V	B	GRM39B103M25PT	K22144802		1-	B	b5
C 1093	CHIP CAP.	120pF	50V	CH	GRM1882C1H121JA01D	K22174237		1-	A	G5
C 1094	CHIP CAP.	0.047uF	16V	B	GRM39B473K16PT	K22124804		1-	A	G5
C 1096	CHIP CAP.	0.047uF	16V	B	GRM39B473K16PT	K22124804		1-	A	G5
C 1098	CHIP CAP.	0.0047uF	50V	B	GRM188B11H472KA01D	K22174817		1-	A	G5
C 1099	CHIP CAP.	0.047uF	16V	B	GRM39B473K16PT	K22124804		1-	B	e6
C 1101	CHIP CAP.	0.001uF	50V	B	GRM188B11H102KA01D	K22174809		1-	B	g4
C 1102	CHIP CAP.	0.001uF	50V	B	GRM188B11H102KA01D	K22174809		1-	B	g4
C 1103	CHIP CAP.	0.001uF	50V	B	GRM188B11H102KA01D	K22174809		1-	B	f5
C 1104	CHIP CAP.	0.001uF	50V	B	GRM188B11H102KA01D	K22174809		1-	B	f4
C 1105	CHIP CAP.	15pF	50V	CH	GRM1882C1H150JA01D	K22174215		1-	A	C4
C 1106	CHIP CAP.	0.001uF	50V	B	GRM188B11H102KA01D	K22174809		1-	A	C4
C 1107	CHIP CAP.	0.001uF	50V	B	GRM188B11H102KA01D	K22174809		1-	A	D4
C 1108	CHIP CAP.	15pF	50V	CH	GRM1882C1H150JA01D	K22174215		1-	A	C4
C 1109	CHIP CAP.	0.001uF	50V	B	GRM188B11H102KA01D	K22174809		1-	A	C4
C 1110	CHIP CAP.	0.001uF	50V	B	GRM188B11H102KA01D	K22174809		1-	B	f4
C 1111	CHIP CAP.	0.1uF	16V	B	GRM188B11C104KA01D	K22124805		1-	A	H6
C 1112	CHIP CAP.	0.01uF	25V	B	GRM39B103M25PT	K22144802		1-	B	a6
C 1113	CHIP CAP.	0.001uF	50V	B	GRM188B11H102KA01D	K22174809		1-	A	H6
C 1114	CHIP CAP.	47pF	50V	CH	GRM1882C1H470JA01D	K22174227		1-	A	G6
C 1115	CHIP TA.CAP.	10uF	10V		TAJA106M010Y	K78100072		1-	A	H6
C 1116	CHIP CAP.	47pF	50V	CH	GRM1882C1H470JA01D	K22174227		1-	A	G6
C 1117	CHIP CAP.	0.1uF	16V	B	GRM188B11C104KA01D	K22124805		1-	A	G6
C 1118	CHIP CAP.	0.1uF	16V	B	GRM188B11C104KA01D	K22124805		1-	A	G6
C 1119	CHIP CAP.	0.01uF	25V	B	GRM39B103M25PT	K22144802		1-	B	b5
C 1120	CHIP CAP.	0.033uF	16V	R	GRM188R11C333KA01D	K22124801		1-	B	a4
C 1121	CHIP CAP.	0.047uF	16V	B	GRM39B473K16PT	K22124804		1-	B	b6
C 1122	CHIP CAP.	0.022uF	25V	B	GRM39B223K25PT	K22144807		1-	B	a4
C 1123	CHIP CAP.	0.1uF	16V	B	GRM188B11C104KA01D	K22124805		1-	B	a4
C 1124	AL.ELECTRO.CAP.	10uF	16V		RE2-16V100MMA	K40129004		1-	A	A2
C 1125	CHIP CAP.	0.001uF	50V	B	GRM188B11H102KA01D	K22174809		1-	A	F7
C 1126	CHIP CAP.	0.001uF	50V	B	GRM188B11H102KA01D	K22174809		1-	A	F6
C 1127	CHIP CAP.	0.001uF	50V	B	GRM188B11H102KA01D	K22174809		1-	A	F7
C 1128	CHIP CAP.	0.001uF	50V	B	GRM188B11H102KA01D	K22174809		1-	A	F6
C 1129	CHIP CAP.	0.001uF	50V	B	GRM188B11H102KA01D	K22174809		1-	A	F7
C 1130	CHIP CAP.	47pF	50V	CH	GRM1882C1H470JA01D	K22174227		1-	A	B6
C 1131	CHIP CAP.	33pF	50V	CH	GRM1882C1H330JA01D	K22174223		1-	A	C3
C 1132	CHIP CAP.	33pF	50V	CH	GRM1882C1H330JA01D	K22174223		1-	A	C3
C 1133	CHIP CAP.	0.001uF	50V	B	GRM188B11H102KA01D	K22174809		1-	A	C3
C 1134	CHIP CAP.	0.001uF	50V	B	GRM188B11H102KA01D	K22174809		1-	A	E3
C 1135	CHIP CAP.	0.001uF	50V	B	GRM188B11H102KA01D	K22174809		1-	A	D3
C 1136	CHIP CAP.	0.001uF	50V	B	GRM188B11H102KA01D	K22174809		1-	A	G6
C 1137	CHIP CAP.	39pF	50V	CH	GRM1882C1H390JA01D	K22174225		1-	A	G6
C 1138	CHIP CAP.	43pF	50V	CH	GRM1882C1H430JZ01D	K22174226		1-	A	G6
C 1139	CHIP CAP.	0.047uF	16V	B	GRM39B473K16PT	K22124804		1-	B	b5
C 1140	CHIP CAP.	0.001uF	50V	B	GRM188B11H102KA01D	K22174809		1-	B	h1
C 1141	CHIP CAP.	0.001uF	50V	B	GRM188B11H102KA01D	K22174809		1-	B	h1
C 1142	CHIP CAP.	0.1uF	16V	B	GRM188B11C104KA01D	K22124805		1-	B	h3
C 1143	CHIP CAP.	0.001uF	50V	B	GRM188B11H102KA01D	K22174809		1-	B	g6
C 1144	AL.ELECTRO.CAP.	470uF	16V		RE3-16V471M 470UF	K40129066		1-	A	A4
C 1145	CHIP CAP.	0.1uF	16V	B	GRM188B11C104KA01D	K22124805		1-	B	g6
C 1146	CHIP CAP.	0.001uF	50V	B	GRM188B11H102KA01D	K22174809		1-	B	h6
C 1147	AL.ELECTRO.CAP.	100uF	16V		RC2-16V101MB	K40129038		1-	A	A7
C 1148	CHIP CAP.	47pF	50V	CH	GRM1552C1H470JZ01D	K22178228		1-	A	F7
C 1149	CHIP CAP.	0.001uF	50V	B	GRM188B11H102KA01D	K22174809		1-	A	F6
C 1150	CHIP CAP.	0.001uF	50V	B	GRM188B11H102KA01D	K22174809		1-	A	F6
C 1151	CHIP CAP.	0.001uF	50V	B	GRM155B11H102KA01D	K22178809		1-	A	F7
C 1152	CHIP CAP.	0.001uF	50V	B	GRM188B11H102KA01D	K22174809		1-	B	c6
C 1153	CHIP CAP.	0.001uF	50V	B	GRM155B11H102KA01D	K22178809		1-	A	F7
C 1154	CHIP CAP.	0.001uF	50V	B	GRM188B11H102KA01D	K22174809		1-	A	F6
C 1155	CHIP CAP.	0.001uF	50V	B	GRM155B11H102KA01D	K22178809		1-	A	F7
C 1156	CHIP CAP.	0.001uF	50V	B	GRM188B11H102KA01D	K22174809		1-	A	F6

REF	DESCRIPTION	VALUE	V/W	TOL.	MFR'S DESIG	VXSTD P/N	VERS.	LOT	SIDE	LAY ADR
C 1157	CHIP CAP.	0.01uF	25V	B	GRM39B103M25PT	K22144802		1-	A	E3
C 1158	CHIP CAP.	0.001uF	50V	B	GRM188B11H102KA01D	K22174809		1-	A	F3
C 1161	CHIP CAP.	0.047uF	16V	B	GRM39B473K16PT	K22124804		1-	B	d4
C 1162	CHIP CAP.	0.001uF	50V	B	GRM188B11H102KA01D	K22174809		1-	B	c4
C 1163	AL.ELECTRO.CAP.	10uF	16V		RE2-16V100MMA	K40129004		1-	A	E3
C 1164	CHIP TA.CAP.	4.7uF	16V		TAJA475M016Y	K78120079		1-	B	c4
C 1165	CHIP CAP.	0.001uF	50V	B	GRM188B11H102KA01D	K22174809		1-	B	c4
C 1166	CHIP CAP.	0.01uF	25V	B	GRM39B103M25PT	K22144802		1-	A	G5
C 1167	CHIP CAP.	0.001uF	50V	B	GRM188B11H102KA01D	K22174809		1-	A	F4
C 1168	CHIP CAP.	0.01uF	25V	B	GRM39B103M25PT	K22144802		1-	A	F4
C 1170	CHIP CAP.	8pF	50V	CH	GRM1882C1H8R0DZ01D	K22174209		1-	A	F5
C 1171	CHIP CAP.	1pF	50V	CK	GRM1884C1H1R0CZ01D	K22174202		1-	A	F5
C 1173	CHIP CAP.	0.1uF	16V	B	GRM188B11C104KA01D	K22124805		1-	B	c5
C 1174	CHIP CAP.	56pF	50V	CH	GRM1882C1H560JA01D	K22174229		1-	A	F5
C 1175	CHIP CAP.	0.01uF	25V	B	GRM39B103M25PT	K22144802		1-	A	F5
C 1176	CHIP CAP.	0.1uF	16V	B	GRM188B11C104KA01D	K22124805		1-	B	g6
C 1177	CHIP CAP.	0.001uF	50V	B	GRM188B11H102KA01D	K22174809		1-	B	b7
C 1178	CHIP CAP.	0.022uF	25V	B	GRM39B223K25PT	K22144807		1-	B	b7
C 1179	CHIP CAP.	0.001uF	50V	B	GRM155B11H102KA01D	K22178809		1-	A	F7
C 1180	CHIP CAP.	0.001uF	50V	B	GRM188B11H102KA01D	K22174809		1-	A	F6
C 1181	CHIP CAP.	0.001uF	50V	B	GRM155B11H102KA01D	K22178809		1-	A	G7
C 1182	CHIP CAP.	0.001uF	50V	B	GRM188B11H102KA01D	K22174809		1-	A	G6
C 1183	CHIP CAP.	0.001uF	50V	B	GRM155B11H102KA01D	K22178809		1-	A	G7
C 1184	CHIP CAP.	0.001uF	50V	B	GRM188B11H102KA01D	K22174809		1-	B	b6
C 1185	CHIP CAP.	0.001uF	50V	B	GRM155B11H102KA01D	K22178809		1-	A	G7
C 1186	CHIP CAP.	0.001uF	50V	B	GRM188B11H102KA01D	K22174809		1-	A	G6
C 1187	CHIP CAP.	0.001uF	50V	B	GRM188B11H102KA01D	K22174809		1-	A	G6
C 1188	CHIP CAP.	0.01uF	25V	B	GRM39B103M25PT	K22144802		1-	A	G4
C 1189	CERAMIC CAP.	0.001uF	100V	CH	GRM42-6CH102J100PT	K22201202		1-	A	F3
C 1190	CHIP TA.CAP.	10uF	10V		TAJA106M010Y	K78100072		1-	A	G4
C 1191	CHIP CAP.	0.001uF	50V	B	GRM188B11H102KA01D	K22174809		1-	A	G4
C 1192	CHIP CAP.	0.001uF	50V	B	GRM188B11H102KA01D	K22174809		1-	A	F4
C 1193	CHIP CAP.	0.1uF	16V	B	GRM188B11C104KA01D	K22124805		1-	B	c4
C 1194	CHIP CAP.	0.001uF	50V	B	GRM188B11H102KA01D	K22174809		1-	B	b4
C 1196	CHIP CAP.	22pF	50V	CH	GRM1882C1H220JA01D	K22174219		1-	A	F4
C 1198	CHIP CAP.	39pF	50V	CH	GRM1882C1H390JA01D	K22174225		1-	A	F5
C 1199	CHIP CAP.	0.5pF	50V	CK	GRM1884C1HR50BZ01D	K22174265		1-	A	G4
C 1200	CHIP CAP.	5pF	50V	CH	GRM1882C1H5R0CZ01D	K22174206		1-	A	G5
C 1201	CHIP CAP.	0.1uF	16V	B	GRM188B11C104KA01D	K22124805		1-	B	c5
C 1202	CHIP CAP.	0.1uF	16V	B	GRM188B11C104KA01D	K22124805		1-	B	b4
C 1204	CHIP TA.CAP.	22uF	6.3V		TAJA226M006Y	K78080086		1-	B	c5
C 1205	CHIP CAP.	470pF	50V	CH	GRM1882C1H471JA01D	K22174249		1-	B	b7
C 1206	CHIP CAP.	0.022uF	25V	B	GRM39B223K25PT	K22144807		1-	B	b7
C 1207	CHIP CAP.	0.0047uF	50V	B	GRM188B11H472KA01D	K22174817		1-	B	b7
C 1208	CHIP CAP.	1uF	6.3V	B	GRM188B10J105KA01D	K22084801		1-	B	b7
C 1209	CHIP CAP.	1uF	6.3V	B	GRM188B10J105KA01D	K22084801		1-	B	g6
C 1210	CHIP CAP.	18pF	500V	CH	CF316CH180J500AT	K22271258		1-	A	G3
C 1211	CHIP CAP.	18pF	500V	CH	CF316CH180J500AT	K22271258		1-	A	G3
C 1212	CHIP CAP.	27pF	50V	CH	GRM1882C1H270JA01D	K22174221		1-	A	H4
C 1213	CHIP CAP.	22pF	500V	CH	CF316CH220J500AT	K22271259		1-	A	G3
C 1214	CHIP CAP.	0.01uF	25V	B	GRM39B103M25PT	K22144802		1-	B	b4
C 1215	CHIP CAP.	0.001uF	50V	B	GRM188B11H102KA01D	K22174809		1-	B	b4
C 1216	CHIP CAP.	0.01uF	25V	B	GRM39B103M25PT	K22144802		1-	B	a4
C 1217	CHIP CAP.	0.001uF	50V	B	GRM188B11H102KA01D	K22174809		1-	B	a3
C 1218	CHIP CAP.	33pF	50V	CH	GRM1882C1H330JA01D	K22174223		1-	A	G5
C 1220	CHIP CAP.	8pF	50V	CH	GRM1882C1H8R0DZ01D	K22174209		1-	A	G4
C 1221	CHIP CAP.	0.001uF	50V	B	GRM188B11H102KA01D	K22174809		1-	A	G5
C 1223	CHIP CAP.	0.001uF	50V	B	GRM188B11H102KA01D	K22174809		1-	A	G5
C 1225	CHIP CAP.	0.1uF	16V	B	GRM188B11C104KA01D	K22124805		1-	B	c6
C 1226	CHIP CAP.	0.0056uF	50V	B	GRM188B11H562KA01D	K22174818		1-	B	c4
C 1227	CHIP CAP.	0.001uF	50V	B	GRM188B11H102KA01D	K22174809		1-	B	c5
C 1228	CHIP CAP.	0.1uF	16V	B	GRM188B11C104KA01D	K22124805		1-	B	c5
C 1230	CHIP CAP.	5pF	50V	CH	GRM1882C1H5R0CZ01D	K22174206		1-	B	b7
C 1231	CHIP TA.CAP.	10uF	10V		TAJA106M010Y	K78100072		1-	B	a6
C 1232	CHIP CAP.	0.1uF	16V	B	GRM188B11C104KA01D	K22124805		1-	B	a7
C 1233	CHIP CAP.	0.001uF	50V	B	GRM188B11H102KA01D	K22174809		1-	B	b7
C 1236	CHIP CAP.	33pF	500V	CH	CF316CH330J500AT	K22271261		1-	A	G2
C 1237	CHIP CAP.	1pF	200V	CK	GRM2194C2D1R0CY21D	K22230208		1-	A	H3
C 1239	CHIP CAP.	33pF	500V	CH	CF316CH330J500AT	K22271261		1-	A	H2
C 1240	CHIP CAP.	1pF	200V	CK	GRM2194C2D1R0CY21D	K22230208		1-	A	H3
C 1241	CHIP CAP.	7pF	500V	CH	CF316CH070D500AT	K22271252		1-	A	H2
C 1243	CHIP CAP.	3pF	50V	CJ	GRM1883C1H3R0CZ01D	K22174204		1-	B	a3
C 1244	CHIP CAP.	0.001uF	50V	B	GRM188B11H102KA01D	K22174809		1-	A	G4
C 1245	CHIP CAP.	10pF	50V	CH	GRM1882C1H100JA01D	K22174211		1-	A	G5
C 1248	CHIP CAP.	39pF	50V	CH	GRM1882C1H390JA01D	K22174225		1-	A	H5

# MAIN Unit

## Parts List

REF	DESCRIPTION	VALUE	V/W	TOL.	MFR'S DESIG	VXSTD P/N	VERS.	LOT	SIDE	LAY ADR
C 1249	CHIP CAP.	1pF	50V	CK	GRM1884C1H1R0BZ01D	K22174267		1-	A	H5
C 1250	CHIP CAP.	22pF	50V	CH	GRM1882C1H220JA01D	K22174219		1-	A	H5
C 1251	CHIP CAP.	1pF	50V	CK	GRM1884C1H1R0BZ01D	K22174267		1-	A	H4
C 1252	CHIP CAP.	39pF	50V	CH	GRM1882C1H390JA01D	K22174225		1-	A	H5
C 1253	CHIP CAP.	0.001uF	50V	B	GRM188B11H102KA01D	K22174809		1-	B	c4
C 1254	CHIP CAP.	0.001uF	50V	B	GRM188B11H102KA01D	K22174809		1-	B	c4
C 1255	CHIP CAP.	0.01uF	25V	B	GRM39B103M25PT	K22144802		1-	B	c5
C 1256	CHIP CAP.	0.001uF	50V	B	GRM188B11H102KA01D	K22174809		1-	B	c4
C 1257	CHIP CAP.	0.01uF	25V	B	GRM39B103M25PT	K22144802		1-	B	c5
C 1258	CHIP CAP.	0.0022uF	50V	B	GRM188B11H222KA01D	K22174813		1-	B	c5
C 1259	CHIP CAP.	0.01uF	25V	B	GRM39B103M25PT	K22144802		1-	B	c5
C 1260	CHIP CAP.	1uF	6.3V	B	GRM188B10J105KA01D	K22084801		1-	B	b6
C 1261	CHIP CAP.	0.001uF	50V	B	GRM188B11H102KA01D	K22174809		1-	B	b7
C 1262	CHIP CAP.	27pF	50V	CH	GRM1882C1H270JA01D	K22174221		1-	B	b6
C 1263	CHIP CAP.	0.001uF	50V	B	GRM188B11H102KA01D	K22174809		1-	B	b6
C 1264	CHIP CAP.	12pF	500V	CH	CF316CH120J500AT	K22271256		1-	A	H1
C 1265	CERAMIC CAP.	0.001uF	100V	CH	GRM42-6CH102J100PT	K22201202		1-	A	H1
C 1266	CHIP CAP.	100pF	50V	CH	GRM1882C1H101JA01D	K22174235		1-	A	H5
C 1267	CHIP CAP.	4pF	50V	CH	GRM1882C1H4R0CZ01D	K22174205		1-	B	a3
C 1268	CHIP CAP.	0.5pF	50V	CK	GRM1884C1HR50BZ01D	K22174265		1-	A	H5
C 1270	CHIP TA.CAP.	10uF	10V		TAJA106M010Y	K78100072		1-	B	c4
C 1273	CHIP CAP.	1uF	6.3V	B	GRM188B10J105KA01D	K22084801		1-	B	a6
C 1274	CHIP CAP.	1uF	6.3V	B	GRM188B10J105KA01D	K22084801		1-	B	a6
C 1275	CHIP CAP.	1uF	6.3V	B	GRM188B10J105KA01D	K22084801		1-	A	E7
C 1276	CHIP CAP.	1uF	6.3V	B	GRM188B10J105KA01D	K22084801		1-	B	g7
C 1277	CHIP CAP.	0.0022uF	50V	B	GRM188B11H222KA01D	K22174813		1-	A	H5
C 1278	CHIP CAP.	0.0056uF	50V	B	GRM188B11H562KA01D	K22174818		1-	A	H6
C 1279	CHIP CAP.	0.1uF	16V	B	GRM188B11C104KA01D	K22124805		1-	A	G5
C 1280	CHIP CAP.	0.1uF	16V	B	GRM188B11C104KA01D	K22124805		1-	A	G5
C 1281	CHIP CAP.	0.001uF	50V	B	GRM155B11H102KA01D	K22178809		1-	A	G7
C 1282	CHIP CAP.	0.001uF	50V	B	GRM188B11H102KA01D	K22174809		1-	A	D6
C 1283	CHIP CAP.	2.2uF	10V	B	GRM188B31A225KE18D	K22104805		1-	A	F6
CD1001	CERAMIC DISC				JTBC450C7	H7901500		1-	A	G7
CF1001	CERAMIC FILTER				ALFYM450G=K	H3900534		1-	A	H6
CF1002	CERAMIC FILTER				ALFYM450F=K	H3900531		1-	A	H5
D 1001	DIODE				1SS400 TE61	G2070634		1-	B	g5
D 1002	DIODE				HVC350B-TRF	G2070596		1-	A	C6
D 1003	SURGE ABSORBER				P6KA18	Q9000721		1-	A	B2
D 1004	DIODE				HSC277TRF	G2070584		1-	A	C6
D 1005	DIODE				HSC277TRF	G2070584		1-	A	C6
D 1006	DIODE				HVC350B-TRF	G2070596		1-	A	E6
D 1007	DIODE				HVC350B-TRF	G2070596		1-	A	E6
D 1008	DIODE				DAN222 TL	G2070174		1-	B	c5
D 1009	DIODE				DA221 TL	G2070178		1-	B	e6
D 1010	DIODE				DAN235E TL	G2070612		1-	A	C4
D 1011	DIODE				DA221 TL	G2070178		1-	A	G5
D 1012	DIODE				DAN222 TL	G2070174		1-	B	a5
D 1013	DIODE				DA221 TL	G2070178		1-	A	H5
D 1014	DIODE				DAN222 TL	G2070174		1-	B	a6
D 1015	DIODE				EDZ TE-61 5.1B	G2070998		1-	B	b5
D 1016	DIODE				DA221 TL	G2070178		1-	A	G6
D 1017	DIODE				HVC350B-TRF	G2070596		1-	A	G5
D 1018	DIODE				XB15A709A0HR	G2070826		1-	A	G3
D 1019	DIODE				XB15A709A0HR	G2070826		1-	A	G3
D 1020	DIODE				RLS135 TE-11	G2070128		1-	A	H4
D 1021	DIODE				HVC350B-TRF	G2070596		1-	A	G5
D 1022	DIODE				1SS321 TE85R	G2070076		1-	B	a3
D 1023	DIODE				1SS400 TE61	G2070634		1-	A	G5
D 1024	DIODE				HVC350B-TRF	G2070596		1-	A	H5
D 1025	DIODE				HVC350B-TRF	G2070596		1-	A	H5
D 1026	DIODE				1SS400 TE61	G2070634		1-	A	E7
D 1028	DIODE				RLS135 TE-11	G2070128		1-	A	H4
D 1029	DIODE				DAN222 TL	G2070174		1-	B	b5
D 1030	DIODE				1SS400 TE61	G2070634		1-	A	F6
D 1031	DIODE				DAN222 TL	G2070174		1-	B	b5
FB1001	FERRITE BEADS				SMB304729	L9190094		1-	A	A1
FB1002	FERRITE BEADS				SMB304729	L9190094		1-	A	B1
FB1003	FERRITE BEADS				SMB304729	L9190094		1-	A	A2
FB1004	FERRITE BEADS				SMB304729	L9190094		1-	A	B1
FB1005	FERRITE BEADS				SMB304729	L9190094		1-	A	B3
FB1006	FERRITE BEADS				BK1608HS121-T	L9190081		1-	B	h1
FB1007	FERRITE BEADS				BK1608HS121-T	L9190081		1-	B	h1
J 1001	CONNECTOR				SC25-02WS	P0090621		1-	A	A3
J 1002	CONNECTOR				HSJ0836-01-500	P1091085		1-	A	A1
J 1003	CONNECTOR				32FLT-SM2-TB(LF)(SN)	P1091258		1-	A	F6

# MAIN Unit

## Parts List

REF	DESCRIPTION	VALUE	V/W	TOL.	MFR'S DESIG	VXSTD P/N	VERS.	LOT	SIDE	LAY ADR
L 1002	CHIP COIL	0.056uH			LQW2BHN56NG03L	L1690978		1-	A	C6
L 1003	CHIP COIL	0.018uH			LQW18AN18NG00D	L1690883		1-	A	C6
L 1004	M.RFC	0.1uH			TFL0816-100N	L1690981		1-	A	C5
L 1005	M.RFC	0.047uH			TFL0816-47	L1690499		1-	B	f4
L 1006	M.RFC	0.082uH			TFL0816-82N	L1690980		1-	A	C4
L 1007	M.RFC	0.047uH			TFL0816-47	L1690499		1-	A	C3
L 1008	M.RFC	1uH			LK1608 1R0K-T	L1690687		1-	A	G6
L 1009	M.RFC	1uH			LK1608 1R0K-T	L1690687		1-	A	G6
L 1010	COIL	0.212uH			AS051047-212N	L0022834		1-	A	F4
L 1011	M.RFC	1uH			ELJ-ND1R0JF	L1690977		1-	A	F5
L 1012	CHIP COIL	0.1uH			LQW18ANR10G00D	L1690892		1-	A	F5
L 1013	COIL	0.033uH			AS1005-33NK	L0022546		1-	A	G3
L 1014	COIL	0.047uH			AS0805-47NK	L0022539		1-	A	H4
L 1015	CHIP COIL	0.1uH			LQW18ANR10G00D	L1690892		1-	A	G5
L 1016	M.RFC	1uH			ELJ-ND1R0JF	L1690977		1-	A	G4
L 1017	COIL	0.033uH			AS1005-33NK	L0022546		1-	A	G3
L 1018	COIL	0.033uH			AS1005-33NK	L0022546		1-	A	H2
L 1019	COIL	0.033uH			AS1005-33NK	L0022546		1-	A	H2
L 1020	CHIP COIL	0.1uH			LQW18ANR10G00D	L1690892		1-	A	G5
L 1021	CHIP COIL	0.022uH			LQW18AN22NG00D	L1690884		1-	A	H5
L 1022	COIL	0.012uH			AS080336-12N	L0022810		1-	A	H1
L 1024	CHIP COIL	0.082uH			LQW18AN82NG00D	L1690891		1-	A	H4
Q 1001	TRANSISTOR				2SC4154-T11-1E	G3341548E		1-	B	g5
Q 1003	TRANSISTOR				DTC144EE TL	G3070075		1-	A	C6
Q 1004	TRANSISTOR				DTC144EE TL	G3070075		1-	A	D7
Q 1005	IC				LM2902PWR	G1094009		1-	B	e6
Q 1006	IC				LM2904PWR	G1094010		1-	B	d5
Q 1007	TRANSISTOR				2SA1774 TL R	G3117748R		1-	A	D6
Q 1008	FET				2SJ562-TD	G3705628		1-	A	B4
Q 1009	TRANSISTOR				2SC5231C9-TL	G3352318I		1-	A	C6
Q 1010	TRANSISTOR				2SC5374-TL	G3353748		1-	A	C5
Q 1011	IC				MB15A01PFV1-G-BND-EF	G1092545		1-	A	D6
Q 1012	TRANSISTOR				2SC4154-T11-1E	G3341548E		1-	B	d6
Q 1013	TRANSISTOR				DTC144EE TL	G3070075		1-	B	d6
Q 1014	TRANSISTOR				DTC144EE TL	G3070075		1-	A	C4
Q 1015	IC				KIA7808API	G1093164		1-	A	A5
Q 1016	IC				S-812C50AUA-C3E-T2	G1093652		1-	B	g4
Q 1017	TRANSISTOR				2SC5374-TL	G3353748		1-	A	C5
Q 1018	TRANSISTOR				DTC144EE TL	G3070075		1-	B	d5
Q 1019	TRANSISTOR				DTC144EE TL	G3070075		1-	B	d5
Q 1020	TRANSISTOR				DTC144EE TL	G3070075		1-	B	d6
Q 1021	TRANSISTOR				2SC4154-T11-1E	G3341548E		1-	B	f5
Q 1022	TRANSISTOR				DTC144EE TL	G3070075		1-	B	f5
Q 1023	TRANSISTOR				2SC5374-TL	G3353748		1-	A	C4
Q 1024	TRANSISTOR				2SA1774 TL R	G3117748R		1-	B	f4
Q 1025	TRANSISTOR				FMMTL718TA	G3070335		1-	B	f4
Q 1026	TRANSISTOR				2SC5226-5-TL	G3352268E		1-	A	C4
Q 1027	TRANSISTOR				2SA1774 TL R	G3117748R		1-	B	b6
Q 1028	IC				NJM2591V-TE1	G1094024		1-	A	G6
Q 1029	TRANSISTOR				2SA1774 TL R	G3117748R		1-	B	b5
Q 1030	IC				RA60H1317M1	G1094220		1-	A	C2
Q 1031	TRANSISTOR				DTC144EE TL	G3070075		1-	B	b6
Q 1032	TRANSISTOR				2SC4400-4-TL	G3344008D		1-	A	G5
Q 1033	TRANSISTOR				2SC4154-T11-1E	G3341548E		1-	A	G6
Q 1034	FET				2SJ364-Q(TX)	G3703648Q		1-	B	b4
Q 1035	IC				LA4425A	G1092241		1-	A	A6
Q 1036	FET				2SJ364-Q(TX)	G3703648Q		1-	B	b5
Q 1037	FET				3SK296ZQ-TL	G4802968		1-	A	F5
Q 1038	IC				LM2904PWR	G1094010		1-	B	b4
Q 1039	FET				2SJ347 TE85R	G3703477		1-	B	c5
Q 1040	TRANSISTOR				DTC144EE TL	G3070075		1-	B	c5
Q 1041	FET				2SJ364-Q(TX)	G3703648Q		1-	B	c5
Q 1042	FET				2SJ364-Q(TX)	G3703648Q		1-	B	a7
Q 1043	IC				M62364FP 600D	G1093033		1-	B	g7
Q 1044	IC				LM2904PWR	G1094010		1-	B	c5
Q 1045	FET				3SK296ZQ-TL	G4802968		1-	A	G4
Q 1046	TRANSISTOR				2SC4154-T11-1E	G3341548E		1-	B	b4
Q 1047	TRANSISTOR				2SC4154-T11-1E	G3341548E		1-	B	c4
Q 1048	IC				CD4094BPWR	G1093866		1-	A	E7
Q 1049	IC				LM2902PWR	G1094009		1-	B	b7
Q 1050	IC				LM2904PWR	G1094010		1-	B	h7
Q 1051	TRANSISTOR				2SC4617 TL R	G3346178R		1-	A	G5
Q 1052	TRANSISTOR				DTC124EE TL	G3070109		1-	A	F6
Q 1053	TRANSISTOR				2SC4617 TL R	G3346178R		1-	A	F6
R 1001	CHIP RES.	3.3k	1/16W	5%	RMC1/16S 332JTH	J24189031		1-	B	g5

# MAIN Unit

## Parts List

REF	DESCRIPTION	VALUE	V/W	TOL.	MFR'S DESIG	VXSTD P/N	VERS.	LOT	SIDE	LAY ADR
R 1002	CHIP RES.	100k	1/16W	5%	RMC1/16S 104JTH	J24189049		1-	A	C6
R 1003	CHIP RES.	47k	1/16W	5%	RMC1/16S 473JTH	J24189045		1-	A	C6
R 1004	CHIP RES.	100	1/16W	5%	RMC1/16S 101JTH	J24189013		1-	A	C6
R 1005	CHIP RES.	12k	1/16W	5%	RMC1/16S 123JTH	J24189038		1-	A	C6
R 1006	CHIP RES.	33	1/16W	5%	RMC1/16S 330JTH	J24189007		1-	A	C6
R 1007	CHIP RES.	1.8k	1/16W	5%	RMC1/16S 182JTH	J24189028		1-	A	D7
R 1008	CHIP RES.	1.8k	1/16W	5%	RMC1/16S 182JTH	J24189028		1-	A	D6
R 1010	CHIP RES.	1.5k	1/16W	5%	RMC1/16S 152JTH	J24189027		1-	A	D6
R 1011	CHIP RES.	100k	1/16W	5%	RMC1/16S 104JTH	J24189049		1-	A	D6
R 1012	CHIP RES.	22k	1/16W	5%	RMC1/16S 223JTH	J24189041		1-	A	D6
R 1013	CHIP RES.	220k	1/16W	5%	RMC1/16S 224JTH	J24189053		1-	A	D6
R 1014	CHIP RES.	10k	1/16W	5%	RMC1/16S 103JTH	J24189037		1-	B	d5
R 1015	CHIP RES.	680	1/16W	5%	RMC1/16S 681JTH	J24189023		1-	B	d5
R 1016	CHIP RES.	560k	1/16W	5%	RMC1/16S 564JTH	J24189058		1-	B	d5
R 1017	CHIP RES.	15k	1/16W	5%	RMC1/16S 153JTH	J24189039		1-	B	d5
R 1018	CHIP RES.	150k	1/16W	5%	RMC1/16S 154JTH	J24189051		1-	B	d5
R 1019	CHIP RES.	47k	1/16W	5%	RMC1/16S 473JTH	J24189045		1-	B	d5
R 1020	CHIP RES.	0	1/16W	5%	RMC1/16S JPTH	J24189070		1-	B	d6
R 1021	CHIP RES.	47k	1/16W	5%	RMC1/16S 473JTH	J24189045		1-	B	d5
R 1022	CHIP RES.	10k	1/16W	5%	RMC1/16S 103JTH	J24189037		1-	B	d5
R 1023	CHIP RES.	68k	1/16W	5%	RMC1/16S 683JTH	J24189047		1-	B	e5
R 1025	CHIP RES.	18k	1/16W	5%	RMC1/16S 183JTH	J24189040		1-	B	d5
R 1026	CHIP RES.	47k	1/16W	5%	RMC1/16S 473JTH	J24189045		1-	B	d6
R 1027	CHIP RES.	100k	1/16W	5%	RMC1/16S 104JTH	J24189049		1-	A	B3
R 1028	CHIP RES.	10k	1/16W	5%	RMC1/16S 103JTH	J24189037		1-	A	C6
R 1029	CHIP RES.	100	1/16W	5%	RMC1/16S 101JTH	J24189013		1-	A	C5
R 1030	CHIP RES.	220k	1/16W	5%	RMC1/16S 224JTH	J24189053		1-	A	C5
R 1031	CHIP RES.	470	1/16W	5%	RMC1/16S 471JTH	J24189021		1-	A	C5
R 1032	CHIP RES.	10k	1/16W	5%	RMC1/16S 103JTH	J24189037		1-	A	C6
R 1033	CHIP RES.	3.3k	1/16W	5%	RMC1/16S 332JTH	J24189031		1-	A	C6
R 1034	CHIP RES.	680	1/16W	5%	RMC1/16S 681JTH	J24189023		1-	A	C6
R 1035	CHIP RES.	1k	1/16W	5%	RMC1/16S 102JTH	J24189025		1-	A	C5
R 1036	CHIP RES.	22k	1/16W	5%	RMC1/16S 223JTH	J24189041		1-	A	C5
R 1037	CHIP RES.	680	1/16W	5%	RMC1/16S 681JTH	J24189023		1-	A	D6
R 1038	CHIP RES.	22	1/16W	5%	RMC1/16S 220JTH	J24189005		1-	A	D6
R 1039	CHIP RES.	22	1/16W	5%	RMC1/16S 220JTH	J24189005		1-	A	E6
R 1040	CHIP RES.	100	1/16W	5%	RMC1/16S 101JTH	J24189013		1-	A	D6
R 1041	CHIP RES.	10k	1/16W	5%	RMC1/16S 103JTH	J24189037		1-	A	D6
R 1042	CHIP RES.	10k	1/16W	5%	RMC1/16S 103JTH	J24189037		1-	A	D6
R 1043	CHIP RES.	10k	1/16W	5%	RMC1/16S 103JTH	J24189037		1-	A	D6
R 1044	CHIP RES.	10k	1/16W	5%	RMC1/16S 103JTH	J24189037		1-	B	d5
R 1045	CHIP RES.	10k	1/16W	5%	RMC1/16S 103JTH	J24189037		1-	B	d5
R 1046	CHIP RES.	47k	1/16W	5%	RMC1/16S 473JTH	J24189045		1-	B	d5
R 1047	CHIP RES.	390k	1/16W	5%	RMC1/16S 394JTH	J24189056		1-	B	e5
R 1048	CHIP RES.	390k	1/16W	5%	RMC1/16S 394JTH	J24189056		1-	B	e5
R 1049	CHIP RES.	68k	1/16W	5%	RMC1/16S 683JTH	J24189047		1-	B	e6
R 1050	CHIP RES.	10k	1/16W	5%	RMC1/16S 103JTH	J24189037		1-	A	C4
R 1051	CHIP RES.	100	1/16W	5%	RMC1/16S 101JTH	J24189013		1-	A	C5
R 1052	CHIP RES.	470k	1/16W	5%	RMC1/16S 474JTH	J24189057		1-	A	C5
R 1053	CHIP RES.	100	1/16W	5%	RMC1/16S 101JTH	J24189013		1-	A	C4
R 1054	CHIP RES.	1k	1/16W	5%	RMC1/16S 102JTH	J24189025		1-	A	C4
R 1055	CHIP RES.	470k	1/16W	5%	RMC1/16S 474JTH	J24189057		1-	A	C4
R 1056	CHIP RES.	22k	1/16W	5%	RMC1/16S 223JTH	J24189041		1-	A	E6
R 1057	CHIP RES.	100k	1/16W	5%	RMC1/16S 104JTH	J24189049		1-	A	E6
R 1058	CHIP RES.	1M	1/16W	5%	RMC1/16S 105JTH	J24189061		1-	A	E7
R 1059	CHIP RES.	390k	1/16W	5%	RMC1/16S 394JTH	J24189056		1-	A	E7
R 1060	CHIP RES.	39k	1/16W	5%	RMC1/16S 393JTH	J24189044		1-	A	E6
R 1061	CHIP RES.	47k	1/16W	5%	RMC1/16S 473JTH	J24189045		1-	A	E6
R 1062	CHIP RES.	220k	1/16W	5%	RMC1/16S 224JTH	J24189053		1-	A	E6
R 1063	CHIP RES.	470k	1/16W	5%	RMC1/16S 474JTH	J24189057		1-	A	E6
R 1064	CHIP RES.	330k	1/16W	5%	RMC1/16S 334JTH	J24189055		1-	A	E6
R 1065	CHIP RES.	47k	1/16W	5%	RMC1/16S 473JTH	J24189045		1-	B	d5
R 1066	CHIP RES.	390k	1/16W	5%	RMC1/16S 394JTH	J24189056		1-	B	e6
R 1067	CHIP RES.	390k	1/16W	5%	RMC1/16S 394JTH	J24189056		1-	B	e6
R 1068	CHIP RES.	100k	1/16W	5%	RMC1/16S 104JTH	J24189049		1-	B	f5
R 1069	CHIP RES.	100k	1/16W	5%	RMC1/16S 104JTH	J24189049		1-	A	C4
R 1070	CHIP RES.	100	1/16W	5%	RMC1/16S 101JTH	J24189013		1-	B	f4
R 1071	CHIP RES.	470	1/16W	5%	RMC1/16S 471JTH	J24189021		1-	A	C4
R 1072	CHIP RES.	2.2k	1/16W	5%	RMC1/16S 222JTH	J24189029		1-	A	G5
R 1073	CHIP RES.	0	1/16W	5%	RMC1/16S JPTH	J24189070		1-	A	E7
R 1075	CHIP RES.	10k	1/16W	5%	RMC1/16S 103JTH	J24189037		1-	B	b5
R 1076	CHIP RES.	390k	1/16W	5%	RMC1/16S 394JTH	J24189056		1-	A	G5
R 1077	CHIP RES.	22k	1/16W	5%	RMC1/16S 223JTH	J24189041		1-	A	G5
R 1079	CHIP RES.	2.2k	1/16W	5%	RMC1/16S 222JTH	J24189029		1-	A	G5
R 1081	CHIP RES.	1k	1/16W	5%	RMC1/16S 102JTH	J24189025		1-	A	G5

# MAIN Unit

## Parts List

	DESCRIPTION	VALUE	V/W	TOL.	MFR'S DESIG	VXSTD P/N	VERS.	LOT	SIDE	LAY ADR
R 1082	CHIP RES.	4.7k	1/16W	5%	RMC1/16S 472JTH	J24189033		1-	A	G6
R 1083	CHIP RES.	2.2k	1/16W	5%	RMC1/16S 222JTH	J24189029		1-	A	G5
R 1084	CHIP RES.	47k	1/16W	5%	RMC1/16S 473JTH	J24189045		1-	B	d6
R 1085	CHIP RES.	47k	1/16W	5%	RMC1/16S 473JTH	J24189045		1-	B	c6
R 1086	CHIP RES.	12k	1/16W	5%	RMC1/16S 123JTH	J24189038		1-	B	e6
R 1087	CHIP RES.	47k	1/16W	5%	RMC1/16S 473JTH	J24189045		1-	B	d6
R 1088	CHIP RES.	10k	1/16W	5%	RMC1/16S 103JTH	J24189037		1-	B	e5
R 1089	CHIP RES.	10k	1/16W	5%	RMC1/16S 103JTH	J24189037		1-	B	e6
R 1090	CHIP RES.	2.2k	1/16W	5%	RMC1/16S 222JTH	J24189029		1-	B	f4
R 1091	CHIP RES.	2.2k	1/16W	5%	RMC1/16S 222JTH	J24189029		1-	B	f4
R 1092	CHIP RES.	2.2k	1/16W	5%	RMC1/16S 222JTH	J24189029		1-	B	f4
R 1093	CHIP RES.	1k	1/16W	5%	RMC1/16S 102JTH	J24189025		1-	B	f4
R 1094	CHIP RES.	2.7k	1/16W	5%	RMC1/16S 272JTH	J24189030		1-	A	C4
R 1095	CHIP RES.	330	1/16W	5%	RMC1/16S 331JTH	J24189019		1-	A	C3
R 1096	CHIP RES.	22	1/16W	5%	RMC1/16S 220JTH	J24189005		1-	A	C4
R 1097	CHIP RES.	470	1/16W	5%	RMC1/16S 471JTH	J24189021		1-	A	C4
R 1098	CHIP RES.	10k	1/16W	5%	RMC1/16S 103JTH	J24189037		1-	B	a6
R 1099	CHIP RES.	1.5k	1/16W	5%	RMC1/16S 152JTH	J24189027		1-	A	C4
R 1100	CHIP RES.	10k	1/16W	5%	RMC1/16S 103JTH	J24189037		1-	B	a6
R 1101	CHIP RES.	33	1/16W	5%	RMC1/16S 330JTH	J24189007		1-	A	C4
R 1102	CHIP RES.	220	1/16W	5%	RMC1/16S 221JTH	J24189017		1-	B	b5
R 1103	CHIP RES.	4.7k	1/16W	5%	RMC1/16S 472JTH	J24189033		1-	B	b6
R 1104	CHIP RES.	47k	1/16W	5%	RMC1/16S 473JTH	J24189045		1-	B	b6
R 1105	CHIP RES.	10k	1/16W	5%	RMC1/16S 103JTH	J24189037		1-	B	b5
R 1106	CHIP RES.	10k	1/16W	5%	RMC1/16S 103JTH	J24189037		1-	B	b5
R 1107	CHIP RES.	1k	1/16W	5%	RMC1/16S 102JTH	J24189025		1-	A	H6
R 1108	CHIP RES.	10k	1/16W	5%	RMC1/16S 103JTH	J24189037		1-	B	b5
R 1109	CHIP RES.	10k	1/16W	5%	RMC1/16S 103JTH	J24189037		1-	B	a6
R 1110	CHIP RES.	10k	1/16W	5%	RMC1/16S 103JTH	J24189037		1-	A	G6
R 1111	CHIP RES.	5.6k	1/16W	5%	RMC1/16S 562JTH	J24189034		1-	A	G6
R 1112	CHIP RES.	100k	1/16W	5%	RMC1/16S 104JTH	J24189049		1-	B	b6
R 1113	CHIP RES.	10k	1/16W	5%	RMC1/16S 103JTH	J24189037		1-	B	a4
R 1114	CHIP RES.	330	1/16W	5%	RMC1/16S 331JTH	J24189019		1-	A	C3
R 1115	CHIP RES.	18	1/16W	5%	RMC1/16S 180JTH	J24189004		1-	A	C3
R 1116	CHIP RES.	330	1/16W	5%	RMC1/16S 331JTH	J24189019		1-	A	C3
R 1117	CHIP RES.	47k	1/16W	5%	RMC1/16S 473JTH	J24189045		1-	A	E3
R 1118	CHIP RES.	47	1/16W	5%	RMC1/16S 470JTH	J24189009		1-	B	b5
R 1119	CHIP RES.	1k	1/16W	5%	RMC1/16S 102JTH	J24189025		1-	A	G5
R 1120	CHIP RES.	220	1/16W	5%	RMC1/16S 221JTH	J24189017		1-	A	G6
R 1121	CHIP RES.	470k	1/16W	5%	RMC1/16S 474JTH	J24189057		1-	A	G5
R 1122	CHIP RES.	47k	1/16W	5%	RMC1/16S 473JTH	J24189045		1-	A	G6
R 1123	CHIP RES.	330k	1/16W	5%	RMC1/16S 334JTH	J24189055		1-	B	b4
R 1124	CHIP RES.	100k	1/16W	5%	RMC1/16S 104JTH	J24189049		1-	B	b5
R 1125	CHIP RES.	330k	1/16W	5%	RMC1/16S 334JTH	J24189055		1-	B	b4
R 1126	CHIP RES.	1	1/10W	5%	RMC1/10T 1R0J	J24205010		1-	B	i3
R 1127	CHIP RES.	10	1/16W	5%	RMC1/16S 100JTH	J24189001		1-	B	g6
R 1128	CHIP RES.	0.33	1W	10%	RMC1 R33KATE	J24309001		1-	A	B6
R 1129	CHIP RES.	10	1/16W	5%	RMC1/16S 100JTH	J24189001		1-	B	g6
R 1130	CHIP RES.	100	1/16W	5%	RMC1/16S 101JTH	J24189013		1-	B	d4
R 1131	CHIP RES.	100	1/16W	5%	RMC1/16S 101JTH	J24189013		1-	B	c4
R 1133	CHIP RES.	100	1/16W	5%	RMC1/16S 101JTH	J24189013		1-	B	c4
R 1134	CHIP RES.	100	1/16W	5%	RMC1/16S 101JTH	J24189013		1-	B	c4
R 1135	CHIP RES.	100	1/16W	5%	RMC1/16S 101JTH	J24189013		1-	B	c4
R 1136	CHIP RES.	1.5k	1/16W	5%	RMC1/16S 152JTH	J24189027		1-	A	G5
R 1137	CHIP RES.	1k	1/16W	5%	RMC1/16S 102JTH	J24189025		1-	A	F5
R 1138	CHIP RES.	2.2k	1/16W	5%	RMC1/16S 222JTH	J24189029		1-	A	F5
R 1139	CHIP RES.	10k	1/16W	5%	RMC1/16S 103JTH	J24189037		1-	B	c5
R 1140	CHIP RES.	33k	1/16W	5%	RMC1/16S 333JTH	J24189043		1-	B	c5
R 1141	CHIP RES.	330k	1/16W	5%	RMC1/16S 334JTH	J24189055		1-	B	b5
R 1142	CHIP RES.	100	1/16W	5%	RMC1/16S 101JTH	J24189013		1-	B	g6
R 1143	CHIP RES.	4.7k	1/16W	5%	RMC1/16S 472JTH	J24189033		1-	B	b7
R 1144	CHIP RES.	330k	1/16W	5%	RMC1/16S 334JTH	J24189055		1-	B	a7
R 1145	CHIP RES.	4.7k	1/16W	5%	RMC1/16S 472JTH	J24189033		1-	A	G4
R 1146	CHIP RES.	100	1W	5%	RMC1 101JTE	J24305101		1-	A	G4
R 1147	CHIP RES.	220k	1/16W	5%	RMC1/16S 224JTH	J24189053		1-	B	b4
R 1148	CHIP RES.	10k	1/16W	5%	RMC1/16S 103JTH	J24189037		1-	B	b4
R 1149	CHIP RES.	100	1/16W	5%	RMC1/16S 101JTH	J24189013		1-	A	F4
R 1150	CHIP RES.	100k	1/16W	5%	RMC1/16S 104JTH	J24189049		1-	A	F4
R 1152	CHIP RES.	220k	1/16W	5%	RMC1/16S 224JTH	J24189053		1-	A	G5
R 1153	CHIP RES.	82	1/16W	5%	RMC1/16S 820JTH	J24189012		1-	A	F5
R 1154	CHIP RES.	47k	1/16W	5%	RMC1/16S 473JTH	J24189045		1-	A	F4
R 1156	CHIP RES.	39k	1/16W	5%	RMC1/16S 393JTH	J24189044		1-	A	F5
R 1157	CHIP RES.	330k	1/16W	5%	RMC1/16S 334JTH	J24189055		1-	B	d5
R 1158	CHIP RES.	330k	1/16W	5%	RMC1/16S 334JTH	J24189055		1-	B	c5
R 1159	CHIP RES.	330k	1/16W	5%	RMC1/16S 334JTH	J24189055		1-	B	c5

# MAIN Unit

## Parts List

REF	DESCRIPTION	VALUE	V/W	TOL.	MFR'S DESIG	VXSTD P/N	VERS.	LOT	SIDE	LAY ADR
R 1160	CHIP RES.	15k	1/16W	5%	RMC1/16S 153JTH	J24189039		1-	B	b7
R 1161	CHIP RES.	100k	1/16W	5%	RMC1/16S 104JTH	J24189049		1-	B	a7
R 1162	CHIP RES.	2.2M	1/16W	5%	RMC1/16S 225JTH	J24189065		1-	B	b7
R 1163	CHIP RES.	10k	1/16W	5%	RMC1/16S 103JTH	J24189037		1-	B	b7
R 1164	CHIP RES.	10k	1/16W	1%	RMC1/16 103FTP	J24183103		1-	B	b7
R 1165	CHIP RES.	100k	1/16W	1%	RMC1/16 104FTP	J24183104		1-	B	b7
R 1166	CHIP RES.	100	1/16W	5%	RMC1/16S 101JTH	J24189013		1-	B	g7
R 1167	CHIP RES.	100	1/16W	5%	RMC1/16S 101JTH	J24189013		1-	B	g7
R 1168	CHIP RES.	100	1/16W	5%	RMC1/16S 101JTH	J24189013		1-	B	g7
R 1169	CHIP RES.	10k	1/16W	5%	RMC1/16S 103JTH	J24189037		1-	B	b4
R 1170	CHIP RES.	15k	1/16W	5%	RMC1/16S 153JTH	J24189039		1-	B	a4
R 1171	CHIP RES.	100	1/16W	5%	RMC1/16S 101JTH	J24189013		1-	A	G4
R 1172	CHIP RES.	220k	1/16W	5%	RMC1/16S 224JTH	J24189053		1-	A	G5
R 1173	CHIP RES.	4.7k	1/16W	5%	RMC1/16S 472JTH	J24189033		1-	A	G4
R 1174	CHIP RES.	47	1/16W	5%	RMC1/16S 470JTH	J24189009		1-	A	G4
R 1175	CHIP RES.	100	1/16W	5%	RMC1/16S 101JTH	J24189013		1-	A	G5
R 1177	CHIP RES.	100k	1/16W	5%	RMC1/16S 104JTH	J24189049		1-	A	G4
R 1178	CHIP RES.	100k	1/16W	5%	RMC1/16S 104JTH	J24189049		1-	A	G4
R 1179	CHIP RES.	680	1/16W	0.5%	MCR01MZPD6800	J24189360		1-	B	c5
R 1180	CHIP RES.	470k	1/16W	5%	RMC1/16S 474JTH	J24189057		1-	B	b4
R 1181	CHIP RES.	2.7k	1/16W	5%	RMC1/16S 272JTH	J24189030		1-	B	b4
R 1182	CHIP RES.	1k	1/16W	5%	RMC1/16S 102JTH	J24189025		1-	B	b5
R 1183	CHIP RES.	10k	1/16W	5%	RMC1/16S 103JTH	J24189037		1-	B	c4
R 1184	CHIP RES.	33k	1/16W	5%	RMC1/16S 333JTH	J24189043		1-	B	c4
R 1185	CHIP RES.	33k	1/16W	0.5%	MCR01MZPD3302	J24189380		1-	B	c5
R 1186	CHIP RES.	33k	1/16W	0.5%	MCR01MZPD3302	J24189380		1-	B	c5
R 1187	CHIP RES.	4.7k	1/16W	5%	RMC1/16S 472JTH	J24189033		1-	B	c5
R 1188	CHIP RES.	100k	1/16W	0.5%	MCR01MZPD1003	J24189386		1-	B	c5
R 1189	CHIP RES.	47k	1/16W	0.5%	MCR01MZPD4702	J24189382		1-	B	c5
R 1190	CHIP RES.	470k	1/16W	0.5%	MCR01MZPD4703	J24189332		1-	B	c5
R 1191	CHIP RES.	2.2M	1/16W	5%	RMC1/16S 225JTH	J24189065		1-	B	b7
R 1192	CHIP RES.	68k	1/16W	1%	RMC1/16 683FTP	J24183683		1-	B	b7
R 1193	CHIP RES.	4.7k	1/16W	1%	RMC1/16 472FTP	J24183472		1-	B	b7
R 1194	CHIP RES.	4.7k	1/16W	1%	RMC1/16 472FTP	J24183472		1-	B	b7
R 1195	CHIP RES.	10k	1/16W	1%	RMC1/16 103FTP	J24183103		1-	B	a7
R 1196	CHIP RES.	68k	1/16W	5%	RMC1/16S 683JTH	J24189047		1-	B	a7
R 1197	CHIP RES.	220k	1/16W	5%	RMC1/16S 224JTH	J24189053		1-	B	a7
R 1198	CHIP RES.	100	1/16W	5%	RMC1/16S 101JTH	J24189013		1-	B	g7
R 1199	CHIP RES.	0	1/16W	5%	RMC1/16S JPTH	J24189070		1-	B	g7
R 1200	CHIP RES.	330k	1/16W	0.5%	MCR01MZPD3303	J24189330		1-	B	h7
R 1201	CHIP RES.	220k	1/16W	0.5%	MCR01MZPD2203	J24189389		1-	B	h7
R 1202	CHIP RES.	330k	1/16W	0.5%	MCR01MZPD3303	J24189330		1-	B	h7
R 1203	CHIP RES.	470k	1/16W	0.5%	MCR01MZPD4703	J24189332		1-	B	h7
R 1204	CHIP RES.	330k	1/16W	0.5%	MCR01MZPD3303	J24189330		1-	B	h7
R 1205	CHIP RES.	56k	1/16W	0.5%	MCR01MZPD5602	J24189383		1-	B	h7
R 1206	CHIP RES.	4.7k	1/16W	5%	RMC1/16S 472JTH	J24189033		1-	B	a3
R 1208	CHIP RES.	0	1/16W	5%	RMC1/16S JPTH	J24189070		1-	A	I4
R 1209	CHIP RES.	47k	1/16W	5%	RMC1/16S 473JTH	J24189045		1-	A	G5
R 1210	CHIP RES.	220k	1/16W	5%	RMC1/16S 224JTH	J24189053		1-	A	H5
R 1211	CHIP RES.	220k	1/16W	5%	RMC1/16S 224JTH	J24189053		1-	A	H5
R 1212	CHIP RES.	150k	1/16W	5%	RMC1/16S 154JTH	J24189051		1-	B	c4
R 1213	CHIP RES.	2.2M	1/16W	5%	RMC1/16S 225JTH	J24189065		1-	B	c4
R 1214	CHIP RES.	2.2k	1/16W	5%	RMC1/16S 222JTH	J24189029		1-	B	c4
R 1215	CHIP RES.	10k	1/16W	5%	RMC1/16S 103JTH	J24189037		1-	B	c4
R 1216	CHIP RES.	0	1/16W	5%	RMC1/16S JPTH	J24189070		1-	B	c4
R 1217	CHIP RES.	22k	1/16W	0.5%	MCR01MZPD2202	J24189378		1-	B	c5
R 1218	CHIP RES.	10k	1/16W	0.5%	MCR01MZPD1002	J24189374		1-	B	c5
R 1219	CHIP RES.	330k	1/16W	5%	RMC1/16S 334JTH	J24189055		1-	B	b6
R 1220	CHIP RES.	220k	1/16W	5%	RMC1/16S 224JTH	J24189053		1-	B	b6
R 1221	CHIP RES.	330k	1/16W	5%	RMC1/16S 334JTH	J24189055		1-	B	b7
R 1222	CHIP RES.	10k	1/16W	5%	RMC1/16S 103JTH	J24189037		1-	B	b6
R 1223	CHIP RES.	68k	1/16W	5%	RMC1/16S 683JTH	J24189047		1-	B	b6
R 1224	CHIP RES.	330k	1/16W	5%	RMC1/16S 334JTH	J24189055		1-	B	b6
R 1225	CHIP RES.	330k	1/16W	5%	RMC1/16S 334JTH	J24189055		1-	A	E7
R 1226	CHIP RES.	5.6k	1/16W	5%	RMC1/16S 562JTH	J24189034		1-	B	a3
R 1228	CHIP RES.	4.7k	1/16W	5%	RMC1/16S 472JTH	J24189033		1-	B	b6
R 1229	CHIP RES.	330k	1/16W	5%	RMC1/16S 334JTH	J24189055		1-	B	b6
R 1230	CHIP RES.	22k	1/16W	5%	RMC1/16S 223JTH	J24189041		1-	B	b6
R 1231	CHIP RES.	0	1/16W	5%	RMC1/16S JPTH	J24189070		1-	B	b6
R 1234	CHIP RES.	3.3k	1/16W	5%	RMC1/16S 332JTH	J24189031		1-	A	G5
R 1235	CHIP RES.	100k	1/16W	5%	RMC1/16S 104JTH	J24189049		1-	A	G5
R 1236	CHIP RES.	2.2k	1/16W	5%	RMC1/16S 222JTH	J24189029		1-	A	G5
R 1237	CHIP RES.	680	1/16W	5%	RMC1/16S 681JTH	J24189023		1-	A	G6
R 1238	CHIP RES.	4.7k	1/16W	5%	RMC1/16S 472JTH	J24189033		1-	B	b7
R 1239	CHIP RES.	2.2k	1/16W	5%	RMC1/16S 222JTH	J24189029		1-	B	b6



# MAIN Unit

## Parts List

REF	DESCRIPTION	VALUE	V/W	TOL.	MFR'S DESIG	VXSTD P/N	VERS.	LOT	SIDE	LAY ADR
R 1240	CHIP RES.	10k	1/16W	5%	RMC1/16S 103JTH	J24189037		1-	B	a6
R 1241	CHIP RES.	4.7k	1/16W	5%	RMC1/16S 472JTH	J24189033		1-	B	b7
R 1242	CHIP RES.	22k	1/16W	5%	RMC1/16S 223JTH	J24189041		1-	A	E7
R 1243	CHIP RES.	22k	1/16W	5%	RMC1/16S 223JTH	J24189041		1-	A	E7
R 1244	CHIP RES.	150k	1/16W	5%	RMC1/16S 154JTH	J24189051		1-	B	c5
R 1245	CHIP RES.	100k	1/16W	5%	RMC1/16S 104JTH	J24189049		1-	B	c5
R 1246	CHIP RES.	0	1/16W	5%	RMC1/16S JPTH	J24189070		1-	A	D6
R 1247	CHIP RES.	470k	1/16W	5%	RMC1/16S 474JTH	J24189057		1-	B	b5
R 1248	CHIP RES.	10k	1/16W	5%	RMC1/16S 103JTH	J24189037		1-	A	F6
R 1249	CHIP RES.	22k	1/16W	5%	RMC1/16S 223JTH	J24189041		1-	A	F6
R 1250	CHIP RES.	22k	1/16W	5%	RMC1/16S 223JTH	J24189041		1-	A	E6
TH1001	THERMISTOR				ERTJ1VV473J	G9090122		1-	A	E7
TH1002	THERMISTOR				ERTJ1VV473J	G9090122		1-	A	E3
X 1001	XTAL S-6	21.25MHz			21.250MHZ	H0103315		1-	A	E6
XF1001	XTAL FILTER	21.7MHz			21R15A 21.700MHZ	H1102395		1-	A	F5
XF1002	XTAL FILTER	21.7MHz			21R15A 21.700MHZ	H1102395		1-	A	F5
	SHIELD CASE					RA0515300		1-		

*MAIN Unit*

*Note*

# CNTL Unit Circuit Diagram

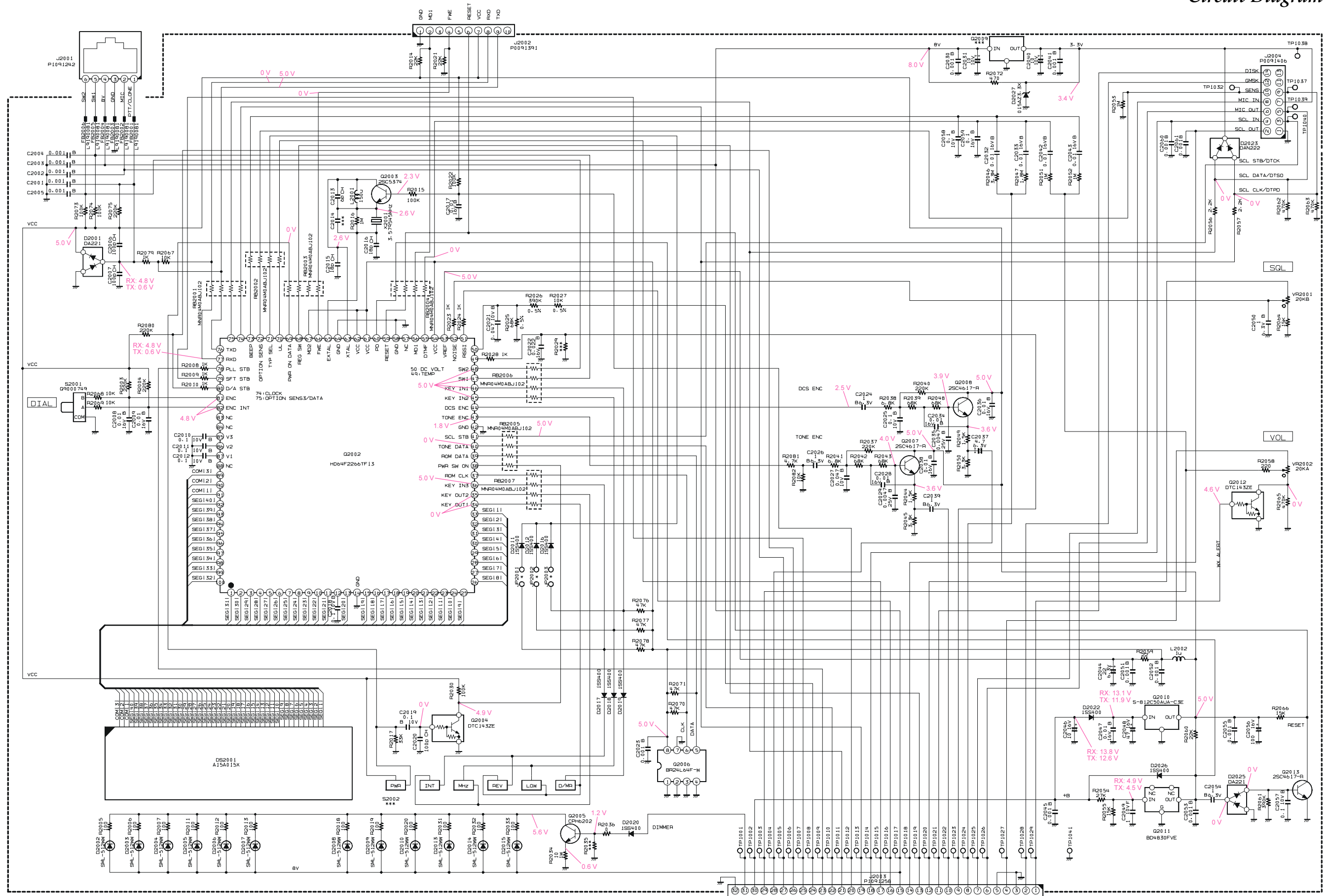

\* J2003

Pin	RX	TX
1	4.6V	4.6V
2	0V	0V
3	0V	0V
4	0V	0V
5	0V	0V
6	0V	0V
7	0V	0V
8	1.9V	1.8V
9	3.0V	3.0V
10	5.0V	0V
11	1.1V	0V
12	3.2V	0V
13	4.9V	4.9V
14	0V	0V
15	8.0V	8.0V
16	0.6V	0V
17	0V	0V
18	0V	0V
19	0V	0V
20	5.0V	5.0V
21	0V	0V
22	0V	0V
23	0V	0V
24	13.8V	12.3V
25	0V	0V
26	0V	0V
27	0V	0V
28	0V	0V
29	0V	0V
30	13.8V	12.4V
31	3.1V	3.1V
32	0V	0V

# CNTL Unit

## Parts Layout (Side A)

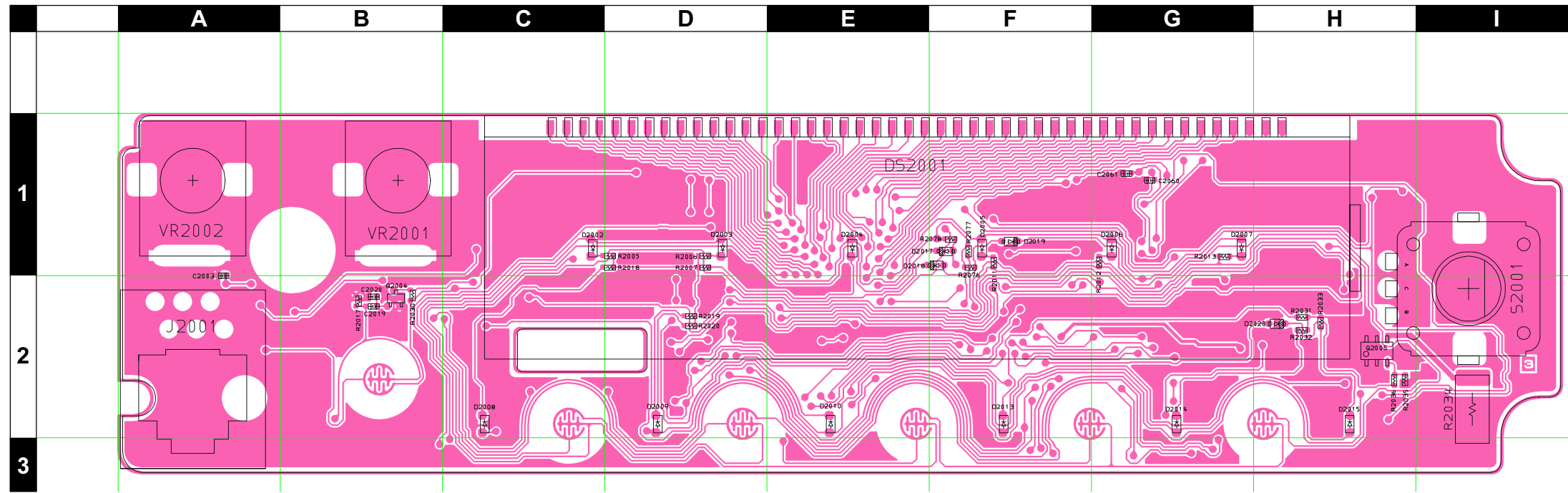

(Side A)

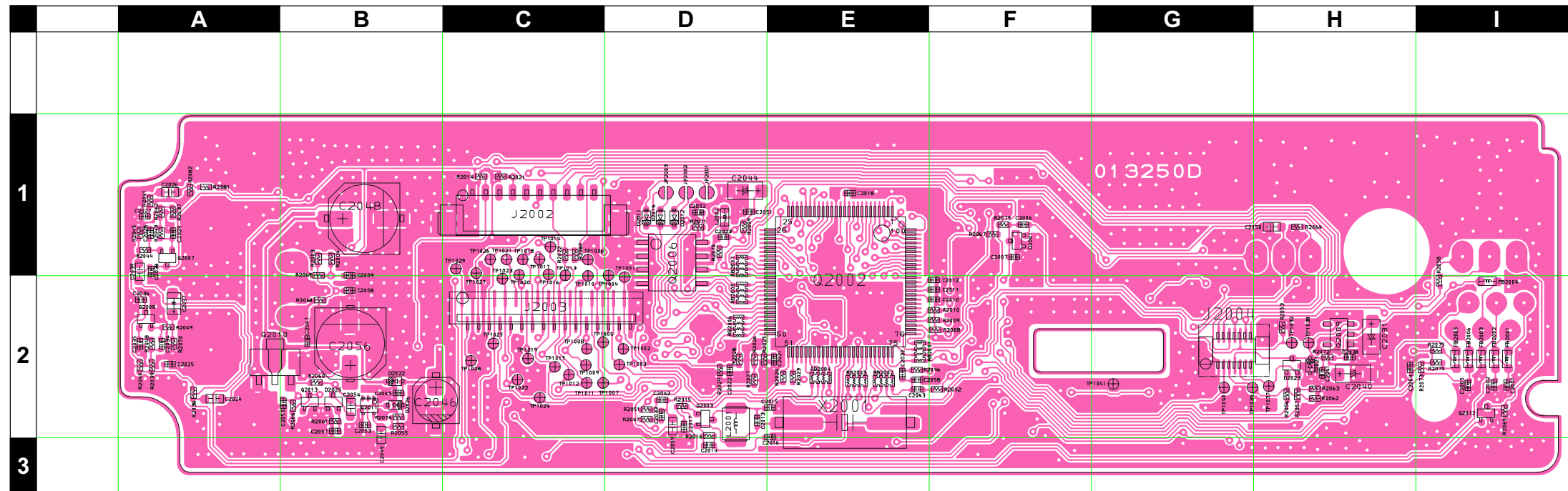
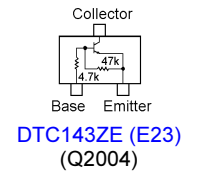
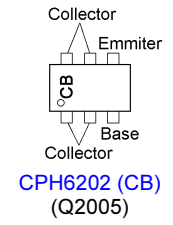

(Side B)

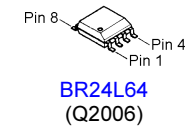
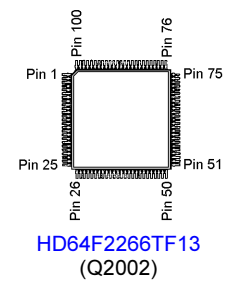
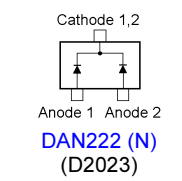
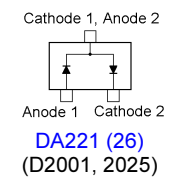
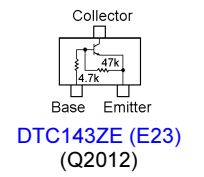
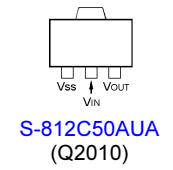
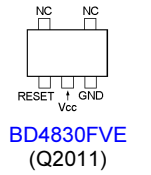
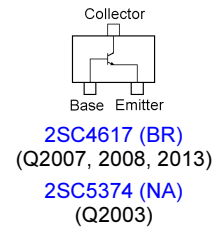

REF	DESCRIPTION	VALUE	V/W	TOL.	MFR'S DESIG	VXSTD P/N	VERS.	LOT	SIDE	LAY ADR
PCB with Components						CB3120001	FT-1802M A2			
						CB3120002	FT-1802M A1			
						CB3120003	FT-1802M A3			
						CB3120004	FT-1802E B1			
						CB3120005	FT-1802E B2			
						CB3120006	FT-1802M B3			
Printed Circuit Board					AH023N000	FR0132500			1-	
C 2001	CHIP CAP.	0.001uF	50V	B	GRM155B11H102KA01D	K22178809		1-	B	i2
C 2002	CHIP CAP.	0.001uF	50V	B	GRM155B11H102KA01D	K22178809		1-	B	i2
C 2003	CHIP CAP.	0.001uF	50V	B	GRM155B11H102KA01D	K22178809		1-	A	A1
C 2004	CHIP CAP.	0.001uF	50V	B	GRM155B11H102KA01D	K22178809		1-	B	h2
C 2005	CHIP CAP.	0.001uF	50V	B	GRM155B11H102KA01D	K22178809		1-	B	i2
C 2006	CHIP CAP.	100pF	50V	CH	GRM1552C1H101JD01D	K22178236		1-	B	f1
C 2007	CHIP CAP.	100pF	50V	CH	GRM1552C1H101JD01D	K22178236		1-	B	f1
C 2008	CHIP CAP.	0.01uF	16V	B	GRM36B103K16PT	K22128804		1-	B	b2
C 2009	CHIP CAP.	0.01uF	16V	B	GRM36B103K16PT	K22128804		1-	B	b1
C 2010	CHIP CAP.	0.1uF	10V	B	GRM36B104K10PT	K22108802		1-	B	f2
C 2011	CHIP CAP.	0.1uF	10V	B	GRM36B104K10PT	K22108802		1-	B	f2
C 2012	CHIP CAP.	0.1uF	10V	B	GRM36B104K10PT	K22108802		1-	B	f2
C 2013	CHIP CAP.	6pF	50V	CH	GRM1552C1H6R0DZ01D	K22178208		1-	B	d2
C 2015	CHIP CAP.	18pF	50V	CH	GRM1552C1H180JZ01D	K22178218		1-	B	e2
C 2016	CHIP CAP.	18pF	50V	CH	GRM1552C1H180JZ01D	K22178218		1-	B	e2
C 2017	CHIP CAP.	0.01uF	16V	B	GRM36B103K16PT	K22128804		1-	B	d2
C 2018	CHIP CAP.	0.1uF	10V	B	GRM36B104K10PT	K22108802		1-	B	e1
C 2019	CHIP CAP.	0.1uF	10V	B	GRM36B104K10PT	K22108802		1-	A	B2
C 2020	CHIP CAP.	100pF	50V	CH	GRM1552C1H101JD01D	K22178236		1-	A	B2
C 2021	CHIP CAP.	0.047uF	10V	B	GRM36B473K10PT	K22108801		1-	B	e2
C 2022	CHIP CAP.	0.022uF	16V	B	GRM36B223K16PT	K22128806		1-	B	d2
C 2023	CHIP CAP.	0.001uF	50V	B	GRM155B11H102KA01D	K22178809		1-	B	d1
C 2024	CHIP CAP.	1uF	6.3V	B	GRM188B10J105KA01D	K22084801		1-	B	a2
C 2025	CHIP CAP.	0.1uF	10V	B	GRM36B104K10PT	K22108802		1-	B	a2
C 2026	CHIP CAP.	1uF	6.3V	B	GRM188B10J105KA01D	K22084801		1-	B	a1
C 2027	CHIP CAP.	0.047uF	10V	B	GRM36B473K10PT	K22108801		1-	B	a1
C 2028	CHIP CAP.	0.01uF	16V	B	GRM36B103K16PT	K22128804		1-	B	a1
C 2029	CHIP CAP.	0.0047uF	25V	B	GRM36B472K25PT	K22148830		1-	B	a1
C 2030	CHIP CAP.	0.001uF	50V	B	GRM155B11H102KA01D	K22178809		1-	B	h2
C 2031	CHIP TA.CAP.	10uF	10V		TAJA106M010Y	K78100072		1-	B	h2
C 2032	CHIP CAP.	0.01uF	16V	B	GRM36B103K16PT	K22128804		1-	B	e2
C 2033	CHIP CAP.	0.01uF	16V	B	GRM36B103K16PT	K22128804		1-	B	d2
C 2034	CHIP CAP.	0.01uF	16V	B	GRM36B103K16PT	K22128804		1-	B	a2
C 2035	CHIP CAP.	0.0047uF	25V	B	GRM36B472K25PT	K22148830		1-	B	a2
C 2036	CHIP CAP.	0.01uF	16V	B	GRM36B103K16PT	K22128804		1-	B	a2
C 2037	CHIP TA.CAP.	4.7uF	6.3V		TESVSP0J475M-8R	K78080053		1-	B	a2
C 2038	CHIP CAP.	0.01uF	16V	B	GRM36B103K16PT	K22128804		1-	B	a1
C 2039	CHIP CAP.	1uF	6.3V	B	GRM188B10J105KA01D	K22084801		1-	B	a1
C 2040	CHIP TA.CAP.	10uF	10V		TAJA106M010Y	K78100072		1-	B	h2
C 2041	CHIP CAP.	0.001uF	50V	B	GRM155B11H102KA01D	K22178809		1-	B	h2
C 2042	CHIP CAP.	0.01uF	16V	B	GRM36B103K16PT	K22128804		1-	B	d2
C 2043	CHIP CAP.	0.01uF	16V	B	GRM36B103K16PT	K22128804		1-	B	e2
C 2044	CHIP TA.CAP.	22uF	6.3V		TAJA226M006Y	K78080086		1-	B	d1
C 2045	CHIP CAP.	0.001uF	50V	B	GRM155B11H102KA01D	K22178809		1-	B	b2
C 2046	AL.ELECTRO.CAP.	10uF	16V		RV4-16V100MD46-RR2	K48120018		1-	B	b2
C 2047	CHIP CAP.	0.01uF	16V	B	GRM36B103K16PT	K22128804		1-	B	b2
C 2048	AL.ELECTRO.CAP.	47uF	16V		RV4-16V470MF46-RR2	K48120019		1-	B	b1
C 2049	CHIP CAP.	1uF	10V	F	GRM188F11A105ZA01D	K22105001		1-	B	b2
C 2050	CHIP CAP.	1uF	6.3V	B	GRM188B10J105KA01D	K22084801		1-	B	h1
C 2051	CHIP CAP.	0.001uF	50V	B	GRM155B11H102KA01D	K22178809		1-	B	d1
C 2052	CHIP CAP.	0.001uF	50V	B	GRM155B11H102KA01D	K22178809		1-	B	d1
C 2053	CHIP CAP.	0.001uF	50V	B	GRM155B11H102KA01D	K22178809		1-	B	b2
C 2054	CHIP CAP.	1uF	6.3V	B	GRM188B10J105KA01D	K22084801		1-	B	b2
C 2055	CHIP CAP.	0.001uF	50V	B	GRM155B11H102KA01D	K22178809		1-	B	b2
C 2056	AL.ELECTRO.CAP.	100uF	16V		ECEV1CA101WP	K48120012		1-	B	b2
C 2057	CHIP CAP.	0.1uF	10V	B	GRM36B104K10PT	K22108802		1-	B	b2
C 2058	CHIP CAP.	0.1uF	10V	B	GRM36B104K10PT	K22108802		1-	B	e2
C 2059	CHIP CAP.	0.1uF	16V	B	GRM188B11C104KA01D	K22124805		1-	B	d2
C 2060	CHIP CAP.	0.001uF	50V	B	GRM155B11H102KA01D	K22178809		1-	A	G1
C 2061	CHIP CAP.	0.001uF	50V	B	GRM155B11H102KA01D	K22178809		1-	A	G1
D 2001	DIODE				DA221 TL	G2070178		1-	B	f1
D 2002	LED				SML-512WWT86	G2071104		1-	A	C1
D 2003	LED				SML-512WWT86	G2071104		1-	A	D1
D 2004	LED				SML-512WWT86	G2071104		1-	A	E1
D 2005	LED				SML-512WWT86	G2071104		1-	A	F1
D 2006	LED				SML-512WWT86	G2071104		1-	A	G1
D 2007	LED				SML-512WWT86	G2071104		1-	A	G1
D 2008	LED				SML-512WWT86	G2071104		1-	A	C2

# CNTL Unit

## Parts List

REF	DESCRIPTION	VALUE	V/W	TOL.	MFR'S DESIG	VXSTD P/N	VERS.	LOT	SIDE	LAY ADR
D 2009	LED				SML-512WWT86	G2071104		1-	A	D2
D 2010	LED				SML-512WWT86	G2071104		1-	A	E2
D 2011	DIODE				1SS400 TE61	G2070634		1-	B	d1
D 2012	DIODE				1SS400 TE61	G2070634		1-	B	d1
D 2013	LED				SML-512WWT86	G2071104		1-	A	F2
D 2014	LED				SML-512WWT86	G2071104		1-	A	G2
D 2015	LED				SML-512WWT86	G2071104		1-	A	H2
D 2016	DIODE				1SS400 TE61	G2070634		1-	B	d1
D 2017	DIODE				1SS400 TE61	G2070634		1-	A	F1
D 2018	DIODE				1SS400 TE61	G2070634		1-	A	F1
D 2019	DIODE				1SS400 TE61	G2070634		1-	A	F1
D 2020	DIODE				1SS400 TE61	G2070634		1-	A	H2
D 2022	DIODE				1SS400 TE61	G2070634		1-	B	b2
D 2023	DIODE				DAN222 TL	G2070174		1-	B	h2
D 2025	DIODE				DA221 TL	G2070178		1-	B	b2
D 2026	DIODE				1SS400 TE61	G2070634		1-	B	b2
D 2027	DIODE				015AZ3.3X-TPH3	G2071078		1-	B	h2
DS2001	LCD				AH023N A15A015X	G6090169		1-	A	E1
FB2001	FERRITE BEADS				BK1608HS121-T	L9190081		1-	B	i2
FB2002	FERRITE BEADS				BK1608HS121-T	L9190081		1-	B	i2
FB2003	FERRITE BEADS				BK1608HS121-T	L9190081		1-	B	i2
FB2004	FERRITE BEADS				BK1608HS121-T	L9190081		1-	B	i2
FB2005	FERRITE BEADS				BK1608HS121-T	L9190081		1-	B	i2
FB2006	FERRITE BEADS				BK1608HS121-T	L9190081		1-	B	i2
J 2001	CONNECTOR				MJD0606KX06L	P1091242		1-	A	A2
J 2002	CONNECTOR				53398-1071	P0091391		1-	B	c1
J 2003	CONNECTOR				32FLT-SM2-TB(LF)(SN)	P1091258		1-	B	c2
J 2004	CONNECTOR				AXK6F14345YJ	P0091406		1-	B	g2
L 2001	M.RFC	150uH			FLC32T-151J	L1690229		1-	B	d2
L 2002	M.RFC	1uH			LK1608 1R0K-T	L1690687		1-	B	d1
Q 2002	IC				HD64F2266TF13	✗		1-	B	e2
Q 2003	TRANSISTOR				2SC5374-TL	G3353748		1-	B	d2
Q 2004	TRANSISTOR				DTC143ZE TL	G3070102		1-	A	B2
Q 2005	TRANSISTOR				CPH6202-TL	G3070265		1-	A	H2
Q 2006	IC				BR24L64F-WE2	G1093876		1-	B	d1
Q 2007	TRANSISTOR				2SC4617 TL R	G3346178R		1-	B	a1
Q 2008	TRANSISTOR				2SC4617 TL R	G3346178R		1-	B	a2
Q 2010	IC				S-812C50AUA-C3E-T2	G1093652		1-	B	a2
Q 2011	IC				BD4830FVE-TR	G1094121		1-	B	b2
Q 2012	TRANSISTOR				DTC143ZE TL	G3070102		1-	B	i2
Q 2013	TRANSISTOR				2SC4617 TL R	G3346178R		1-	B	b2
R 2003	CHIP RES.	220k	1/16W	5%	RMC1/16S 224JTH	J24189053		1-	B	b1
R 2004	CHIP RES.	220k	1/16W	5%	RMC1/16S 224JTH	J24189053		1-	B	b1
R 2005	CHIP RES.	100	1/16W	5%	RMC1/16S 101JTH	J24189013		1-	A	D1
R 2006	CHIP RES.	100	1/16W	5%	RMC1/16S 101JTH	J24189013		1-	A	D1
R 2007	CHIP RES.	100	1/16W	5%	RMC1/16S 101JTH	J24189013		1-	A	D1
R 2008	CHIP RES.	1k	1/16W	5%	RMC1/16S 102JTH	J24189025		1-	B	f2
R 2009	CHIP RES.	1k	1/16W	5%	RMC1/16S 102JTH	J24189025		1-	B	f2
R 2010	CHIP RES.	1k	1/16W	5%	RMC1/16S 102JTH	J24189025		1-	B	f2
R 2011	CHIP RES.	100	1/16W	5%	RMC1/16S 101JTH	J24189013		1-	A	F1
R 2012	CHIP RES.	100	1/16W	5%	RMC1/16S 101JTH	J24189013		1-	A	G1
R 2013	CHIP RES.	100	1/16W	5%	RMC1/16S 101JTH	J24189013		1-	A	G1
R 2014	CHIP RES.	22k	1/16W	5%	RMC1/16S 223JTH	J24189041		1-	B	c1
R 2015	CHIP RES.	100k	1/16W	5%	RMC1/16S 104JTH	J24189049		1-	B	d2
R 2016	CHIP RES.	1M	1/16W	5%	RMC1/16S 105JTH	J24189061		1-	B	d2
R 2017	CHIP RES.	33k	1/16W	5%	RMC1/16S 333JTH	J24189043		1-	A	B2
R 2018	CHIP RES.	100	1/16W	5%	RMC1/16S 101JTH	J24189013		1-	A	D1
R 2019	CHIP RES.	100	1/16W	5%	RMC1/16S 101JTH	J24189013		1-	A	D2
R 2020	CHIP RES.	100	1/16W	5%	RMC1/16S 101JTH	J24189013		1-	A	D2
R 2021	CHIP RES.	22k	1/16W	5%	RMC1/16S 223JTH	J24189041		1-	B	c1
R 2022	CHIP RES.	100k	1/16W	5%	RMC1/16S 104JTH	J24189049		1-	B	c1
R 2023	CHIP RES.	1k	1/16W	5%	RMC1/16S 102JTH	J24189025		1-	B	e2
R 2024	CHIP RES.	1k	1/16W	5%	RMC1/16S 102JTH	J24189025		1-	B	e2
R 2025	CHIP RES.	68k	1/16W	0.5%	MCR01MZPD6802	J24189384		1-	B	d2
R 2026	CHIP RES.	390k	1/16W	0.5%	MCR01MZPD3903	J24189331		1-	B	d2
R 2027	CHIP RES.	10k	1/16W	0.5%	MCR01MZPD1002	J24189374		1-	B	d2
R 2028	CHIP RES.	1k	1/16W	5%	RMC1/16S 102JTH	J24189025		1-	B	d2
R 2030	CHIP RES.	100k	1/16W	5%	RMC1/16S 104JTH	J24189049		1-	A	B2
R 2031	CHIP RES.	100	1/16W	5%	RMC1/16S 101JTH	J24189013		1-	A	H2
R 2032	CHIP RES.	100	1/16W	5%	RMC1/16S 101JTH	J24189013		1-	A	H2
R 2033	CHIP RES.	100	1/16W	5%	RMC1/16S 101JTH	J24189013		1-	A	H2
R 2034	CHIP RES.	10	1W	5%	RMC1 100JTE	J24305100		1-	A	I2
R 2036	CHIP RES.	0	1/16W	5%	RMC1/16S JPTH	J24189070		1-	A	H2
R 2037	CHIP RES.	220k	1/16W	5%	RMC1/16S 224JTH	J24189053		1-	B	a1
R 2038	CHIP RES.	6.8k	1/16W	5%	RMC1/16S 682JTH	J24189035		1-	B	a2

✗: Please contact VERTEX STANDARD

REF	DESCRIPTION	VALUE	V/W	TOL.	MFR'S DESIG	VXSTD P/N	VERS.	LOT	...	LAY ADR
R 2039	CHIP RES.	68k	1/16W	5%	RMC1/16S 683JTH	J24189047		1-	B	a2
R 2040	CHIP RES.	220k	1/16W	5%	RMC1/16S 224JTH	J24189053		1-	B	a2
R 2041	CHIP RES.	6.8k	1/16W	5%	RMC1/16S 682JTH	J24189035		1-	B	a1
R 2042	CHIP RES.	68k	1/16W	5%	RMC1/16S 683JTH	J24189047		1-	B	a1
R 2043	CHIP RES.	68k	1/16W	5%	RMC1/16S 683JTH	J24189047		1-	B	a1
R 2044	CHIP RES.	1.5k	1/16W	5%	RMC1/16S 152JTH	J24189027		1-	B	a1
R 2045	CHIP RES.	3.3k	1/16W	5%	RMC1/16S 332JTH	J24189031		1-	B	a1
R 2046	CHIP RES.	3.3M	1/16W	5%	RMC1/16S 335JTH	J24189324		1-	B	e2
R 2047	CHIP RES.	1.8M	1/16W	5%	RMC1/16S 185JTH	J24189064		1-	B	d2
R 2048	CHIP RES.	68k	1/16W	5%	RMC1/16S 683JTH	J24189047		1-	B	a2
R 2049	CHIP RES.	1.5k	1/16W	5%	RMC1/16S 152JTH	J24189027		1-	B	a2
R 2050	CHIP RES.	3.3k	1/16W	5%	RMC1/16S 332JTH	J24189031		1-	B	a2
R 2051	CHIP RES.	1M	1/16W	5%	RMC1/16S 105JTH	J24189061		1-	B	d2
R 2052	CHIP RES.	1M	1/16W	5%	RMC1/16S 105JTH	J24189061		1-	B	f2
R 2053	CHIP RES.	1M	1/16W	5%	RMC1/16S 105JTH	J24189061		1-	B	h2
R 2054	CHIP RES.	27k	1/16W	5%	RMC1/16S 273JTH	J24189042		1-	B	b2
R 2055	CHIP RES.	15k	1/16W	5%	RMC1/16S 153JTH	J24189039		1-	B	b2
R 2056	CHIP RES.	2.2k	1/16W	5%	RMC1/16S 222JTH	J24189029		1-	B	h2
R 2057	CHIP RES.	2.2k	1/16W	5%	RMC1/16S 222JTH	J24189029		1-	B	h2
R 2058	CHIP RES.	220	1/16W	5%	RMC1/16S 221JTH	J24189017		1-	B	i2
R 2059	CHIP RES.	22	1/16W	5%	RMC1/16S 220JTH	J24189005		1-	B	d1
R 2060	CHIP RES.	22k	1/16W	5%	RMC1/16S 223JTH	J24189041		1-	B	b2
R 2061	CHIP RES.	390k	1/16W	5%	RMC1/16S 394JTH	J24189056		1-	B	b2
R 2062	CHIP RES.	470k	1/16W	5%	RMC1/16S 474JTH	J24189057		1-	B	h2
R 2063	CHIP RES.	470k	1/16W	5%	RMC1/16S 474JTH	J24189057		1-	B	h2
R 2064	CHIP RES.	15k	1/16W	5%	RMC1/16S 153JTH	J24189039		1-	B	h1
R 2065	CHIP RES.	470k	1/16W	5%	RMC1/16S 474JTH	J24189057		1-	B	i2
R 2066	CHIP RES.	15k	1/16W	5%	RMC1/16S 153JTH	J24189039		1-	B	b2
R 2067	CHIP RES.	10k	1/16W	5%	RMC1/16S 103JTH	J24189037		1-	B	f1
R 2068	CHIP RES.	10k	1/16W	5%	RMC1/16S 103JTH	J24189037		1-	B	b2
R 2069	CHIP RES.	10k	1/16W	5%	RMC1/16S 103JTH	J24189037		1-	B	b1
R 2070	CHIP RES.	47k	1/16W	5%	RMC1/16S 473JTH	J24189045		1-	B	d1
R 2071	CHIP RES.	47k	1/16W	5%	RMC1/16S 473JTH	J24189045		1-	B	d1
R 2072	CHIP RES.	470	1/16W	5%	RMC1/16S 471JTH	J24189021		1-	B	h2
R 2073	CHIP RES.	100k	1/16W	5%	RMC1/16S 104JTH	J24189049		1-	B	i2
R 2074	CHIP RES.	100k	1/16W	5%	RMC1/16S 104JTH	J24189049		1-	B	i2
R 2075	CHIP RES.	220k	1/16W	5%	RMC1/16S 224JTH	J24189053		1-	B	i2
R 2076	CHIP RES.	47k	1/16W	5%	RMC1/16S 473JTH	J24189045		1-	A	F1
R 2077	CHIP RES.	47k	1/16W	5%	RMC1/16S 473JTH	J24189045		1-	A	F1
R 2078	CHIP RES.	47k	1/16W	5%	RMC1/16S 473JTH	J24189045		1-	A	F1
R 2079	CHIP RES.	1k	1/16W	5%	RMC1/16S 102JTH	J24189025		1-	B	f1
R 2080	CHIP RES.	220k	1/16W	5%	RMC1/16S 224JTH	J24189053		1-	B	c1
R 2081	CHIP RES.	4.7k	1/16W	5%	RMC1/16S 472JTH	J24189033		1-	B	a1
R 2082	CHIP RES.	10k	1/16W	5%	RMC1/16S 103JTH	J24189037		1-	B	a1
RB2001	BLOCK RES.				MNR04M0ABJ102	J42900039		1-	B	e2
RB2002	BLOCK RES.				MNR04M0ABJ102	J42900039		1-	B	e2
RB2003	BLOCK RES.				MNR04M0ABJ102	J42900039		1-	B	e2
RB2004	BLOCK RES.				MNR04M0ABJ102	J42900039		1-	B	e2
RB2005	BLOCK RES.				MNR04M0ABJ102	J42900039		1-	B	d2
RB2006	BLOCK RES.				MNR04M0ABJ102	J42900039		1-	B	d2
RB2007	BLOCK RES.				MNR04M0ABJ102	J42900039		1-	B	d1
S 2001	ROTARY ENCODER				EC12E2420401	Q9000749		1-	A	I2
VR2001	POT.				WH9011-1B B20K 25/5	J60800288		1-	A	B1
VR2002	POT.				WH9011-1B A20K 25/5	J60800287		1-	A	A1
X 2001	XTAL XPFEGC	3.579545MHz			3.579545MHZ	H0103304		1-	B	e2

# *CNTL Unit*

## *Note*







Copyright 2005  
VERTEX STANDARD CO., LTD.  
All rights reserved

No portion of this manual  
may be reproduced without  
the permission of  
VERTEX STANDARD CO., LTD.

Printed in Japan.